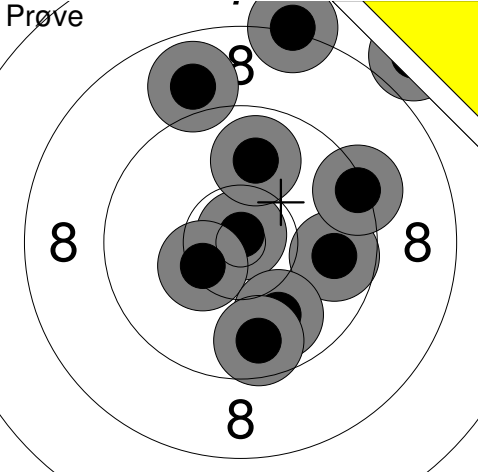
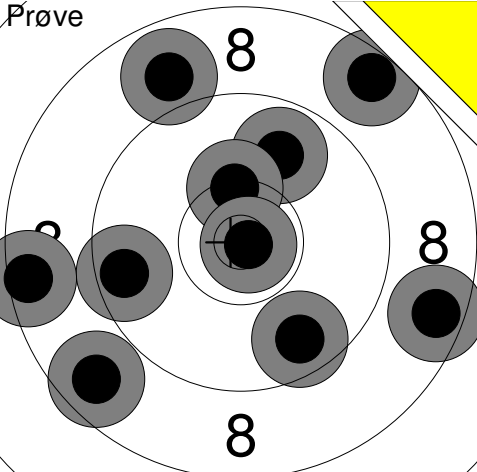
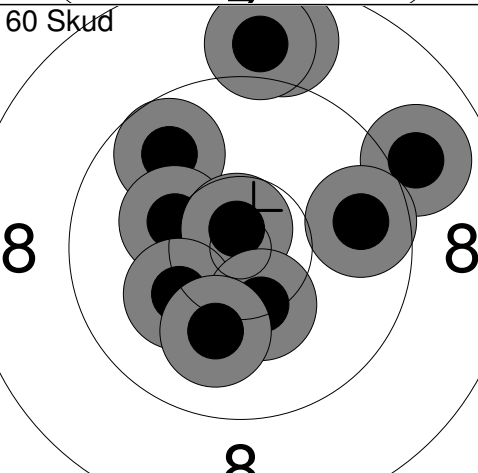
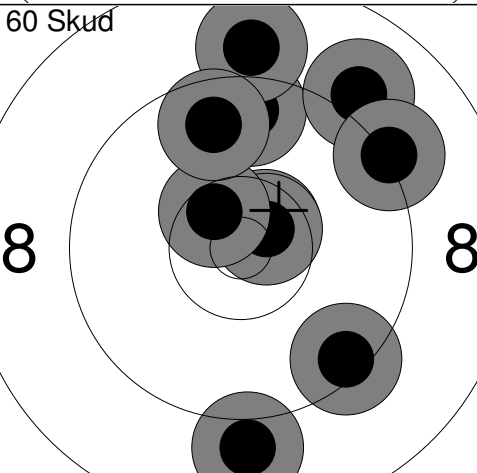
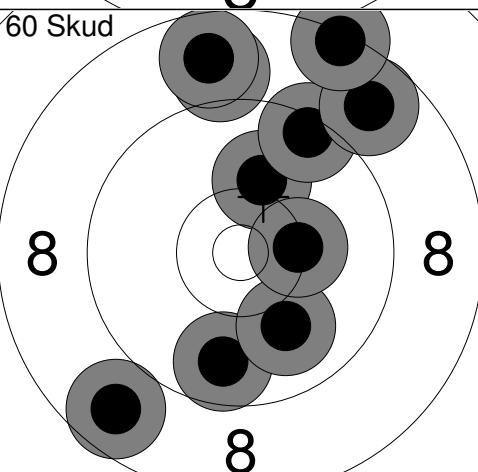
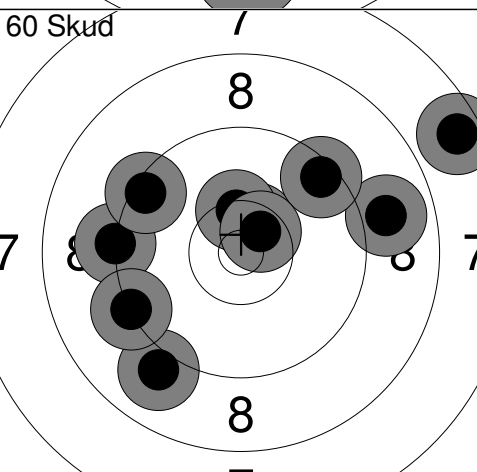
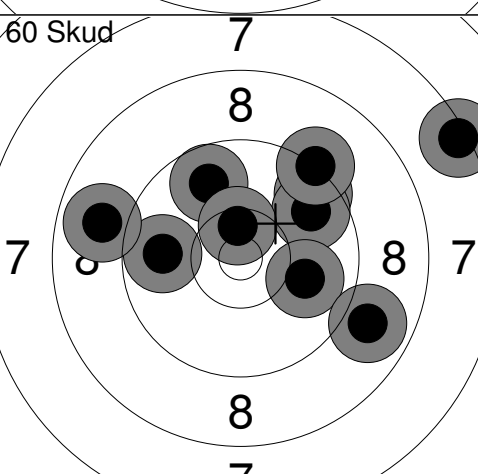
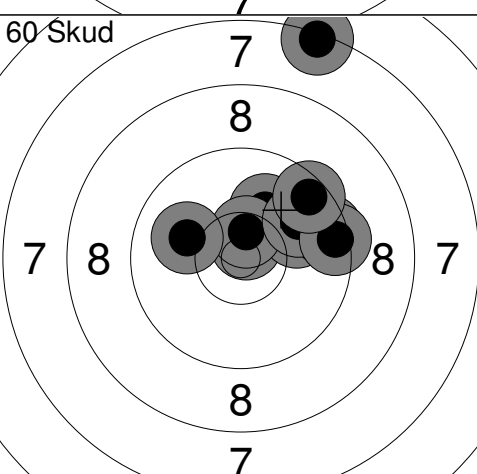
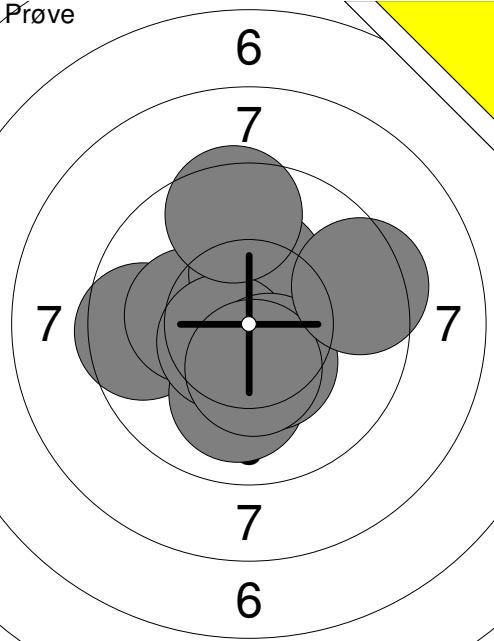
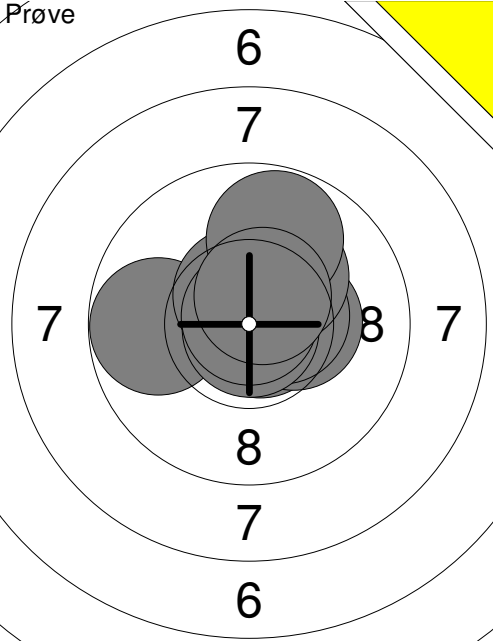
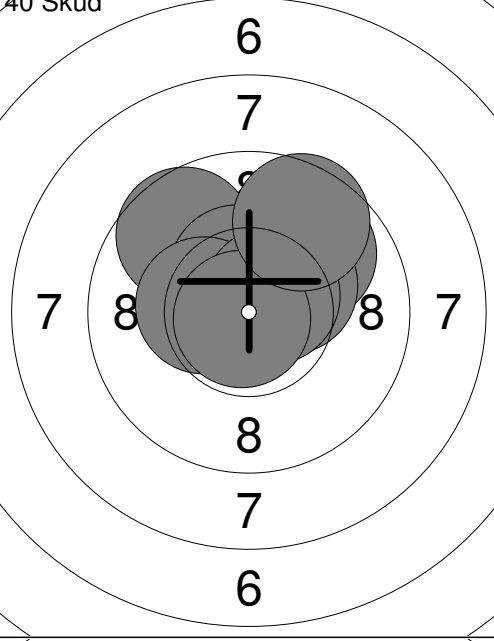
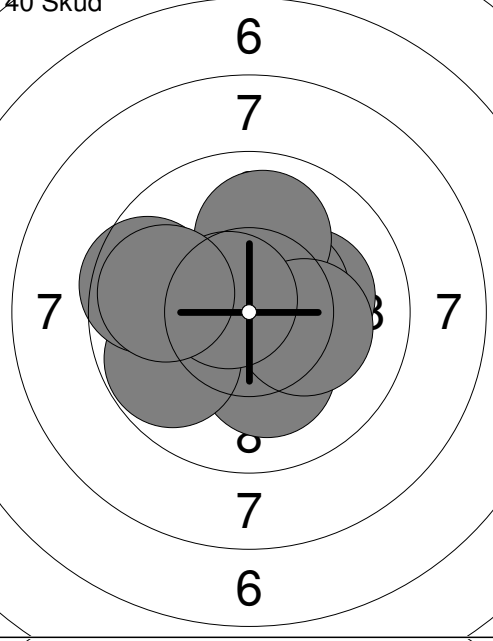
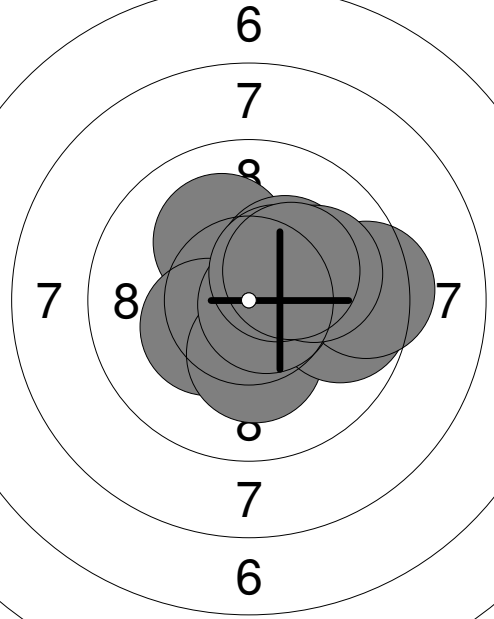
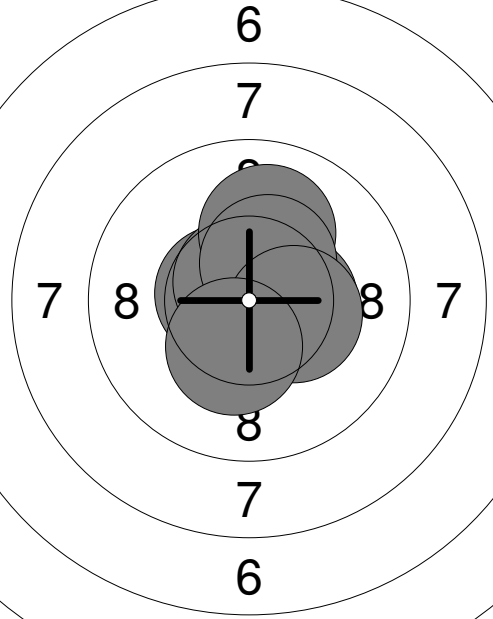

Hold	Skive	Tomas Lauridsen	
50	2		
AAS		Aalborg Skyttekreds	P
Luftstævne		Aalborg Skyttekreds	
Prøve 	1: 9.8 → 2: 7.7 ↗ 3: 8.2 ↑ 4: 8.9 ↑ 5: 10.9x ↑ 6: 10.4x ↙ 7: 9.9 ↘ 8: 9.3 → 9: 9.9 ↑ 10: 9.7 ↘	Prøve 	11: 9.9 ↑ 12: 10.3 ↑ 13: 8.6 → 14: 8.9 ↑ 15: 9.6 ↘ 16: 9.6 ← 17: 8.5 ↗ 18: 8.7 ↘ 19: 8.5 ← 20: 10.9x →
	Serie 88.0		Serie 87.0
	Total 0.0		Total 0.0
60 Skud 	1: 9.8 ↗ 2: 10.2 ↙ 3: 9.0 → 4: 10.8x ↑ 5: 8.8 ↑ 6: 9.7 → 7: 10.2 ↙ 8: 10.3 ↘ 9: 8.9 ↑ 10: 10.1 ↘	60 Skud 	11: 9.6 ↑ 12: 9.4 ↘ 13: 8.9 ↑ 14: 10.6x ↗ 15: 10.6x ↗ 16: 9.0 ↗ 17: 8.9 ↘ 18: 9.2 ↗ 19: 10.5x ↗ 20: 9.7 ↑
	Serie 93.0		Serie 91.0
	Total 93.0		Total 184.0
60 Skud 	21: 10.1 ↑ 22: 9.4 ↑ 23: 8.8 ↗ 24: 9.7 ↘ 25: 8.9 ↑ 26: 8.7 ↘ 27: 10.0 ↘ 28: 10.3 → 29: 8.3 ↑ 30: 8.7 ↑	60 Skud 	31: 7.6 → 32: 10.5x ↑ 33: 9.0 ↘ 34: 9.2 ← 35: 10.4x ↑ 36: 8.9 → 37: 9.3 ← 38: 9.4 ↗ 39: 9.4 ↙ 40: 10.5x ↗
	Serie 88.0		Serie 90.0
	Total 272.0		Total 362.0
60 Skud 	41: 9.6 ↗ 42: 7.4 → 43: 9.8 ↑ 44: 9.7 ↗ 45: 9.2 ↗ 46: 10.5x ↑ 47: 10.0 → 48: 9.8 ← 49: 8.9 ← 50: 8.9 ↘	60 Skud 	51: 10.1 ↑ 52: 10.7x ↑ 53: 10.0 → 54: 9.5 → 55: 10.5x ↑ 56: 9.9 ↗ 57: 9.4 → 58: 10.1 ↙ 59: 9.5 ↗ 60: 7.3 ↑
	Serie 88.0		Serie 93.0
	Total 450.0		Total 543.0

Hold	Skive	Dennis Dalsgaard	
50	4	Aalborg Skyttekreds	H P
AAS	Luftstævne	Aalborg Skyttekreds	
Prøve		1: 9.8 → 2: 4.9 ↓ 3: 8.7 ↗ 4: 4.4 ↓ 5: 7.7 ↗ 6: 5.1 → 7: 6.1 → 8: 7.7 ↗ 9: 8.3 ↓ 10: 6.1 ↓ Serie 64.0 Total 0.0	Prøve 11: 8.0 ↑ 12: 9.9 ← 13: 6.1 → 14: 7.3 ↗ 15: 10.6x → 16: 9.0 ↓ 17: 10.2 → 18: 8.0 → 19: 6.5 → 20: 7.6 ↑ Serie 80.0 Total 0.0
60 Skud		1: 7.8 → 2: 6.5 ↓ 3: 9.0 ↗ 4: 8.6 → 5: 8.9 ↑ 6: 9.0 → 7: 9.4 ← 8: 6.8 ← 9: 10.7x → 10: 6.2 ↗ Serie 78.0 Total 78.0	60 Skud 11: 7.3 ← 12: 9.9 ← 13: 5.2 → 14: 7.6 ↑ 15: 10.2 → 16: 5.4 ↗ 17: 10.7x → 18: 9.2 ← 19: 8.1 ↑ 20: 5.9 ↓ Serie 75.0 Total 153.0
60 Skud		21: 7.9 ↗ 22: 7.0 ↑ 23: 7.7 ↑ 24: 9.3 ↓ 25: 8.0 ↗ 26: 10.5x ↓ 27: 6.0 ↑ 28: 10.8x ↑ 29: 3.8 ↗ 30: 10.3 ← Serie 77.0 Total 230.0	60 Skud 31: 9.6 → 32: 7.6 ↗ 33: 8.9 ↑ 34: 10.4x ↓ 35: 9.8 ↑ 36: 6.6 ↗ 37: 8.0 ↑ 38: 8.7 ↓ 39: 6.0 → 40: 6.9 ↑ Serie 77.0 Total 307.0
60 Skud		41: 4.5 → 42: 9.7 → 43: 7.6 ← 44: 6.4 ↑ 45: 9.4 ↓ 46: 7.8 ↗ 47: 2.6 ↗ 48: 10.5x ↗ 49: 9.2 ↗ 50: 9.3 ↓ Serie 72.0 Total 379.0	60 Skud 51: 7.9 ↗ 52: 8.1 ← 53: 8.8 → 54: 5.9 → 55: 6.1 → 56: 7.3 ↑ 57: 10.0 → 58: 7.5 ↗ 59: 9.1 ↓ 60: 8.8 ↓ Serie 75.0 Total 454.0

Hold	Skive	Christinna Herskind	
50	9	Aalborg Skyttekreds	Aalborg Skyttekreds
AAS		Luftstævne	DJ R
Prøve		1: 9.6 ← 2: 10.0 ↓ 3: 10.2 ✕ 4: 10.6x ➤ 5: 10.3x ↗ 6: 10.6x ✕ 7: 10.4x ↓ 8: 10.4x ↓ 9: 9.4 ➔ 10: 9.5 ↑ Serie 101.0 Total 0.0	Prøve  11: 9.8 ← 12: 10.6x ↗ 13: 10.8x ➤ 14: 10.4x ➤ 15: 10.5x ➤ 16: 10.9x ↓ 17: 10.9x ↗ 18: 10.2x ↗ 19: 9.8 ↗ 20: 10.5x ↗ Serie 104.4 Total 0.0
40 Skud		1: 10.3x ✕ 2: 9.7 ↖ 3: 10.7x ✕ 4: 10.4x ↗ 5: 9.9 ↗ 6: 10.3x ➤ 7: 10.4x ✕ 8: 10.6x ➤ 9: 10.8x ✕ 10: 9.6 ↗ Serie 102.7 Total 102.7	40 Skud  11: 10.7x ➤ 12: 10.2x ↓ 13: 10.2x ➤ 14: 10.5x ➤ 15: 9.8 ↖ 16: 10.0 ↑ 17: 10.2x ➤ 18: 9.6 ← 19: 10.6x ✕ 20: 9.8 ← Serie 101.6 Total 204.3
40 Skud		21: 10.1 ↖ 22: 10.3x ✕ 23: 10.2x ↓ 24: 9.7 ➔ 25: 10.3x ↗ 26: 9.4 ➔ 27: 10.7x ➤ 28: 10.4x ↗ 29: 10.0 ➔ 30: 10.3x ↗ Serie 101.4 Total 305.7	40 Skud  31: 10.4x ➤ 32: 10.8x ✕ 33: 10.7x ➤ 34: 10.7x ➤ 35: 10.6x ✕ 36: 10.7x ↗ 37: 10.0 ↑ 38: 10.4x ↗ 39: 10.3x ➤ 40: 10.3x ↓ Serie 104.9 Total 410.6

Hold	Skive	Lars Ørum		H	R
50	10	Aalborg Skyttekreds			
AAS		Luftstævne		Aalborg Skyttekreds	
Prøve		1: 10.0 ↙ 2: 10.3x ↗ 3: 10.0 ↗ 4: 10.0 → 5: 10.7x → 6: 9.9 ↖ 7: 10.2x ↗ 8: 10.2x ↑ 9: 10.3x ← 10: 10.4x ↗	Prøve		11: 10.3x → 12: 10.8x ↑ 13: 10.0 ↗ 14: 10.3x ↖
		Serie 102.0		Serie 41.4	
		Total 0.0		Total 0.0	
60 Skud		1: 10.5x ↗ 2: 10.6x → 3: 10.3x ↘ 4: 10.3x ↑ 5: 10.1 ← 6: 10.6x ↗ 7: 10.1 ↘ 8: 9.9 ↘ 9: 10.0 ↗ 10: 10.6x ←	60 Skud		11: 10.6x → 12: 10.5x ← 13: 9.7 ↓ 14: 10.6x ← 15: 9.5 ← 16: 10.5x ↑ 17: 10.8x ↑ 18: 10.8x ← 19: 10.7x ↘ 20: 9.8 ←
		Serie 103.0		Serie 103.5	
		Total 103.0		Total 206.5	
60 Skud		21: 10.1 ↘ 22: 10.3x ← 23: 10.6x ↑ 24: 9.9 → 25: 10.7x ↗ 26: 10.6x ↘ 27: 10.6x ← 28: 10.6x ↘ 29: 10.4x ← 30: 10.0 ↘	60 Skud		31: 10.4x ↗ 32: 10.0 ↑ 33: 10.6x ↘ 34: 10.5x ↗ 35: 9.7 ↗ 36: 9.9 ↑ 37: 10.1 ↑ 38: 9.8 → 39: 10.7x ← 40: 9.9 ↖
		Serie 103.8		Serie 101.6	
		Total 310.3		Total 411.9	
60 Skud		41: 10.6x ↑ 42: 10.5x → 43: 10.4x ↗ 44: 10.2x ↗ 45: 10.8x ↗ 46: 10.1 ↗ 47: 10.5x ↘ 48: 10.0 ↗ 49: 10.5x ↘ 50: 10.7x ↘	60 Skud		51: 10.1 ↑ 52: 9.8 ↑ 53: 10.4x ← 54: 10.5x ↘ 55: 10.3x ← 56: 10.2x ↖ 57: 10.5x ↗ 58: 10.2x ← 59: 10.3x ↗ 60: 10.6x ↖
		Serie 104.3		Serie 102.9	
		Total 516.2		Total 619.1	

Hold	Skive	Anders Kildehøj			
51	1				
AAS		BPI			
		S2			
Luftstævne		Aalborg Skyttekreds			
Prøve		1: 8.4 ↘ 2: 8.2 ↘ 3: 9.5 ↙ 4: 9.8 ↘ 5: 10.4x↘ 6: 10.1↙ 7: 9.3 ↗ 8: 9.7 ↑ 9: 10.6x↓ 10: 9.0 ↓ Serie 95.0 Total 0.0	Prøve		11: 9.9 ↓ Serie 9.9 Total 0.0
40 Skud		1: 7.8 ↖ 2: 9.1 ↓ 3: 9.1 ↑ 4: 10.4x↖ 5: 9.0 ↙ 6: 8.7 ↖ 7: 9.6 ↖ 8: 10.2x↖ 9: 9.2 → 10: 8.3 ↘ Serie 91.4 Total 91.4	40 Skud		11: 9.7 ↑ 12: 10.1 ↖ 13: 9.3 → 14: 10.2x↓ 15: 8.8 ← 16: 10.4x↓ 17: 7.0 ↑ 18: 9.9 → 19: 10.1 ↑ 20: 8.8 → Serie 94.3 Total 185.7
40 Skud		21: 10.6x↓ 22: 8.9 ↑ 23: 10.5x↓ 24: 10.7x↗ 25: 9.5 ↗ 26: 10.2x↗ 27: 7.8 → 28: 9.9 → 29: 10.3x↗ 30: 9.0 ↖ Serie 97.4 Total 283.1	40 Skud		31: 9.0 ↖ 32: 10.2x↖ 33: 9.5 ↙ 34: 9.4 ↘ 35: 10.5x↓ 36: 10.2x↘ 37: 9.0 ↓ 38: 9.0 ↑ 39: 10.7x↖ 40: 9.3 ↓ Serie 96.8 Total 379.9

Hold	Skive	Sara Alexis	
51	2	Sara Alexis	
AAS		Viborg Skytteforening	U15-1
Luftstævne		Aalborg Skyttekreds	
Prøve 	1: 9.9 ↗ 2: 9.3 ← 3: 9.2 ↘ 4: 9.4 ← 6: 9.9 ↗ 7: 10.3x→ 8: 10.6x→ 9: 10.6x↘ 10: 9.7 ←	Prøve 	11: 9.3 ↗ 12: 9.6 → 13: 10.0 → 14: 9.3 ↘ 15: 10.4x↘ 16: 9.9 ↓ 17: 10.3x← 18: 10.0 ↖ 19: 10.0 ↗ 20: 10.1 →
	Serie 88.9		Serie 98.9
	Total 0.0		Total 0.0
40 Skud 	1: 10.5x↓ 2: 9.9 ↓ 3: 9.5 → 4: 9.8 ← 5: 9.7 ↓ 6: 10.2x← 7: 9.8 ↗ 8: 9.5 ↓ 9: 10.5x↘ 10: 10.7x↘	40 Skud 	11: 10.1 → 12: 10.1 ↘ 13: 10.7x↗ 14: 10.0 ↗ 15: 9.8 ↓ 16: 9.5 ↗ 17: 10.2x→ 18: 10.7x↘ 19: 10.7x← 20: 9.8 →
	Serie 100.1		Serie 101.6
	Total 100.1		Total 201.7
40 Skud 	21: 10.6x↘ 22: 9.4 ← 23: 10.1 ← 24: 9.8 ← 25: 10.3x→ 26: 10.1 ← 27: 10.7x↑ 28: 10.2x↘ 29: 10.3x← 30: 8.2 ↓	40 Skud 	31: 9.9 ↖ 32: 8.6 → 33: 10.1 ↑ 34: 9.5 ↘ 35: 10.3x↓ 36: 10.5x↓ 37: 10.5x→ 38: 10.2x↘ 39: 10.5x↓ 40: 10.2x↘
	Serie 99.7		Serie 100.3
	Total 301.4		Total 401.7

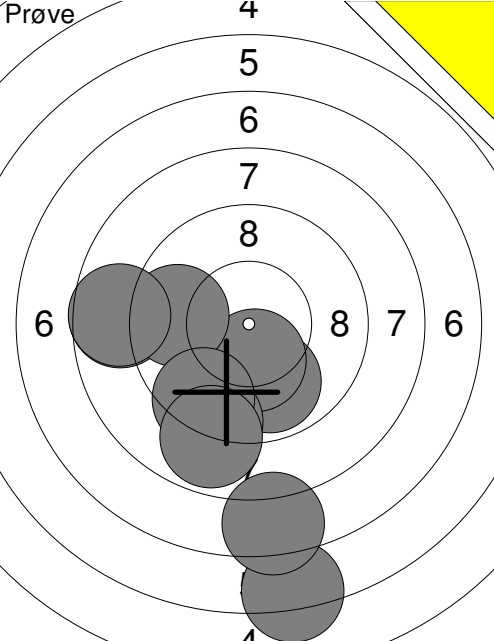
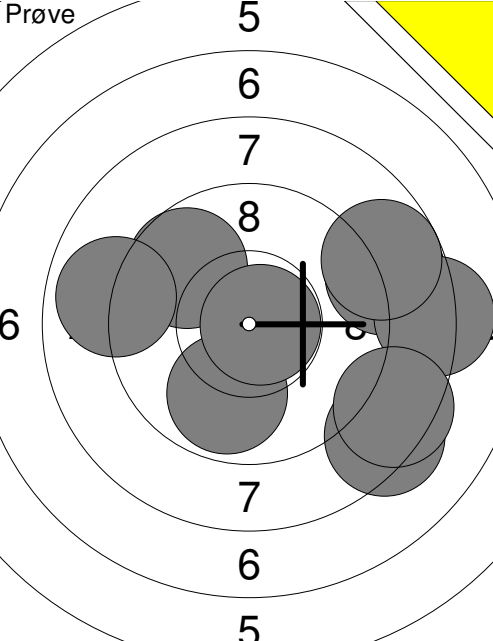
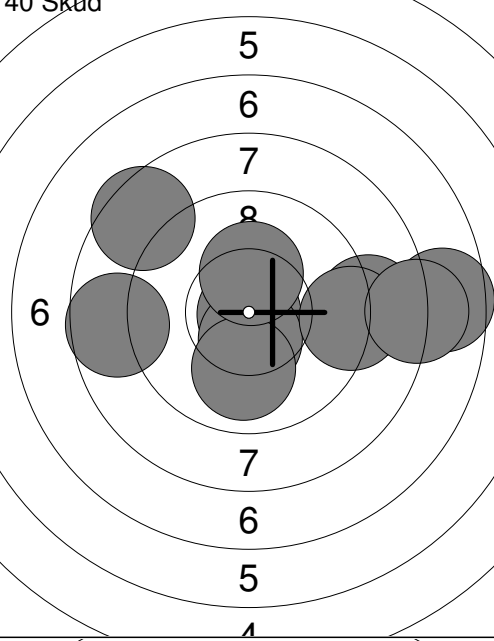
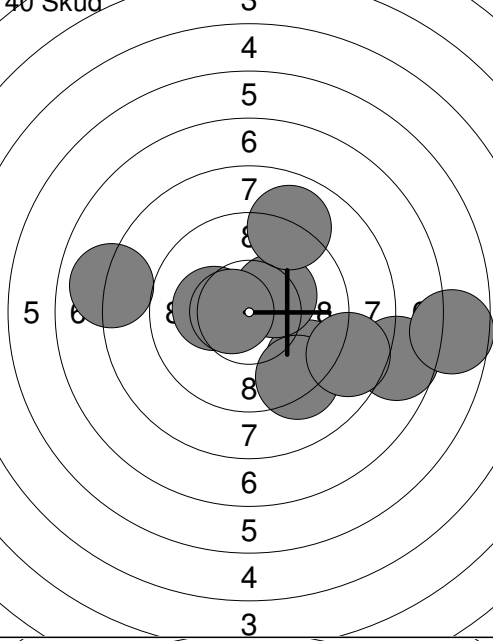
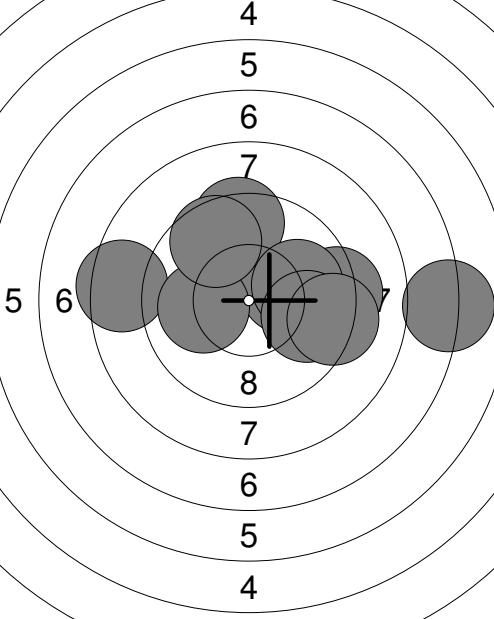
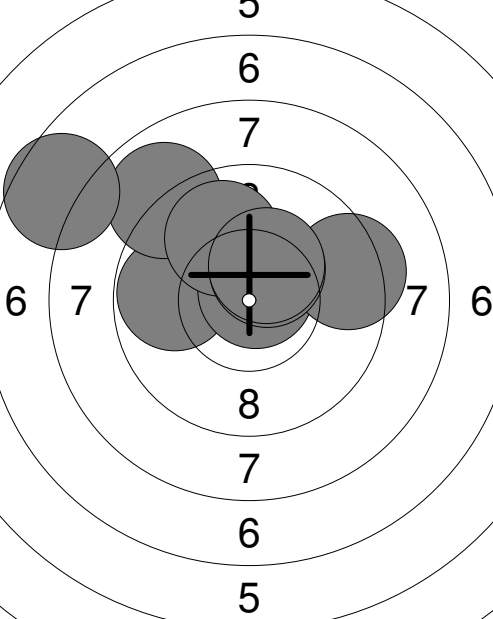
Hold	Skive	Frederik Hedemann		
51	3			
AAS		Vester Hassing Skytteforening	U17-1	
Luftstævne		Aalborg Skyttekreds		
Prøve 	4	1: 6.2 ↓	Prøve 5	11: 9.9 ↓
	5	2: 7.4 ↓		12: 8.8 →
	6	3: 9.9 ↓		13: 8.3 ↘
7	4: 10.3x↓	14: 8.2 →		
	8	5: 8.7 ←		15: 9.7 ↖
	8	6: 9.7 ←		16: 8.9 ←
	7	7: 9.1 ↓		17: 10.8x→
	6	8: 8.7 ←		18: 8.7 →
	6	9: 9.4 ↓		19: 8.5 ↘
	6	10: 8.9 ↓		
	Serie	88.3		Serie 81.8
	Total	0.0		Total 0.0
40 Skud 	4	1: 8.5 ↖	40 Skud 5 	11: 9.3 ↘
	5	2: 7.6 →		12: 7.7 →
	6	3: 8.9 →		13: 9.2 ↘
	7	4: 8.7 ←		14: 10.3x↗
	8	5: 10.9x↓		15: 10.2x←
	8	6: 10.5x↓		16: 10.6x←
	7	7: 9.2 →		17: 8.0 ←
	7	8: 10.0 ↓		18: 8.7 →
	6	9: 8.0 →		19: 9.0 ↗
	6	10: 10.3x↑		20: 6.6 →
	Serie	92.6		Serie 89.6
	Total	92.6		Total 182.2
40 Skud 	4	21: 10.2x↗	40 Skud 5 	31: 10.4x↑
	4	22: 9.2 →		32: 10.6x↗
	5	23: 8.4 ←		33: 9.8 ←
	6	24: 9.4 ↑		34: 10.8x↗
	7	25: 7.1 →		35: 8.9 ↖
	7	26: 10.0 →		36: 9.9 ↗
	6	27: 10.1 ←		37: 9.4 →
	6	28: 9.8 →		38: 10.4x↗
	5	29: 9.3 →		39: 10.3x↗
	5	30: 9.6 ↖		40: 7.6 ↖
	Serie	93.1		Serie 98.1
	Total	275.3		Total 373.4

Hold	Skive	Josefine Laursen	
51	4		
AAS		Viborg Skytteforening	U17-1
Luftstævne		Aalborg Skyttekreds	
Prøve		1: 10.5x↑ 2: 9.8 ↙ 3: 10.7x↓ 4: 10.2x→ 5: 10.2x↓ 6: 10.4x↓ 7: 10.7x↖ 8: 10.4x↓ 9: 9.4 ↙ 10: 9.8 →	Prøve 11: 10.1 ↖ 12: 10.5x↑ 13: 10.6x→ 14: 10.8x↖ 15: 10.3x↓ 16: 10.4x↖ 17: 10.1 ↖ 18: 10.6x↓ 19: 10.6x↓ 20: 10.4x→
		Serie 102.1	Serie 104.4
		Total 0.0	Total 0.0
40 Skud		1: 10.0↖ 2: 10.3x↓ 3: 10.3x↖ 4: 9.6 ↘ 5: 10.2x↗ 6: 10.8x↑ 7: 9.9 ↘ 8: 9.6 ↘ 9: 10.5x→ 10: 9.8 ↖	40 Skud 11: 10.3x↑ 12: 9.9 ↖ 13: 10.0↖ 14: 10.8x↗ 15: 10.6x↑ 16: 9.9 ↖ 17: 10.1 ↑ 18: 9.9 ↖ 19: 10.4x↖ 20: 7.3 ↘
		Serie 101.0	Serie 99.2
		Total 101.0	Total 200.2
40 Skud		21: 10.0 ↑ 22: 10.6x↖ 23: 9.4 ↖ 24: 9.8 → 25: 10.7x↓ 26: 9.5 ↖ 27: 10.8x↗ 28: 10.6x↖ 29: 10.7x→ 30: 10.1↖	40 Skud 31: 10.4x↖ 32: 10.4x↓ 33: 10.3x→ 34: 10.4x↖ 35: 10.4x↓ 36: 10.3x↓ 37: 10.5x↖ 38: 9.8 ↖ 39: 10.7x↓ 40: 9.7 →
		Serie 102.2	Serie 102.9
		Total 302.4	Total 405.3

Hold	Skive	Laila Højfeldt	
51	5		
AAS		Vejle Skytteforening	D
Luftstævne		Aalborg Skyttekreds	
Prøve 	1: 9.3 ↘	Prøve 	11: 10.2 ↘
	2: 10.4x↗		12: 9.7 →
	3: 10.2 ↙		13: 9.6 ↗
	4: 10.1 ↖		14: 9.1 ↗
	5: 10.5x←		15: 9.6 ↙
	6: 9.6 ↙		16: 10.2 →
	7: 9.1 →		17: 9.7 →
	8: 9.1 ↓		18: 10.2 ↗
	9: 9.0 ↘		19: 9.5 ↓
	10: 9.9 ↗		
	Serie 94.0		Serie 84.0
	Total 0.0		Total 0.0
40 Skud 	1: 9.9 ←	40 Skud 	11: 9.9 ←
	2: 8.9 ↗		12: 10.1 ↗
	3: 10.2 ↘		13: 8.1 ↗
	4: 9.0 ↘		14: 9.2 ↘
	5: 10.8x↗		15: 8.3 ↓
	6: 10.0 ↖		16: 10.8x↗
	7: 9.3 ↖		17: 10.2 ↖
	8: 10.4x↘		18: 10.3 ↗
	9: 8.9 ↖		19: 10.7x↘
	10: 9.9 ↙		20: 8.9 ←
	Serie 92.0		Serie 92.0
	Total 92.0		Total 184.0
40 Skud 	21: 9.8 ↘	40 Skud 	31: 9.5 ↗
	22: 10.2 ↓		32: 9.8 ↘
	23: 8.6 ↘		33: 8.3 →
	24: 9.8 ↘		34: 10.4x↘
	25: 10.6x←		35: 8.8 ↗
	26: 8.4 ↗		36: 10.2 ↘
	27: 10.2 ↘		37: 9.3 ↗
	28: 9.0 ↗		38: 8.6 ↓
	29: 10.0 ↗		39: 9.9 →
	30: 10.6x↘		40: 9.4 →
	Serie 93.0		Serie 89.0
	Total 277.0		Total 366.0

Hold	Skive	Silas Højfeldt Kildehøj		
51	6	AAS	BPI	
		Luftstævne	Aalborg Skyttekreds	
Prøve		1: 10.0 → 2: 9.0 → 3: 9.2 ↑ 4: 10.8x ↓ 5: 9.0 ↑ 6: 10.3x → 7: 8.8 → 8: 9.6 ← 9: 10.1 ↖ 10: 10.6x →	40 Skud	 1: 9.3 ← 2: 10.3x → 3: 8.6 ↙ 4: 8.7 ↖ 5: 10.1 ↙ 6: 10.4x ← 7: 9.8 → 8: 9.6 ↗ 9: 9.3 ↖ 10: 10.3x ↓
		Serie 97.4	Serie 96.4	
		Total 0.0	Total 96.4	
40 Skud		11: 8.4 ← 12: 10.3x ↓ 13: 8.8 ↖ 14: 10.6x ↗ 15: 8.6 ↗ 16: 9.9 → 17: 9.8 ↗ 18: 9.7 ← 19: 9.8 ↑ 20: 9.6 ←	40 Skud	 21: 8.2 ↑ 22: 7.8 ↖ 23: 9.6 ↖ 24: 10.1 ↗ 25: 8.1 → 26: 8.5 ← 27: 9.8 ← 28: 9.1 ← 29: 9.9 → 30: 6.2 ↗
		Serie 95.5	Serie 87.3	
		Total 191.9	Total 279.2	
40 Skud		31: 9.2 ↑ 32: 9.3 ↖ 33: 9.4 ↑ 34: 10.0 ↙ 35: 9.1 ↗ 36: 9.0 ↑ 37: 9.4 ↓ 38: 9.0 ↑ 39: 10.3x ↘ 40: 9.6 ↓		
		Serie 94.3		
		Total 373.5		

Hold	Skive	Kathrine Jakobsen			
51	7				
AAS		Vester Hassing Skytteforening	U17-2		
Luftstævne		Aalborg Skyttekreds			
Prøve		1: 7.5 ↓	Prøve		11: 9.7 ↑
		2: 7.4 ↓			12: 10.5x➤
		3: 8.8 ↓			13: 10.3x↙
		4: 8.0 ↓			14: 10.2x➤
		5: 8.5 ↓			15: 10.3x↘
		6: 9.4 ↑			16: 10.1 ↗
		7: 9.3 ↑			17: 10.7x➤
		8: 10.4x↔			18: 10.8x↓
		9: 10.8x↑			19: 9.9 ↓
		10: 9.8 ↑			20: 10.6x↓
		Serie 89.9			Serie 103.1
		Total 0.0			Total 0.0
40 Skud		1: 10.2x↘	40 Skud		11: 10.6x➤
		2: 10.5x↗			12: 10.5x↙
		3: 10.8x↓			13: 9.7 ↑
		4: 10.6x↔			14: 10.3x➤
		5: 10.4x↓			15: 10.0 ↖
		6: 10.4x↓			16: 10.2x➤
		7: 10.1 ↓			17: 10.8x↘
		8: 10.5x↓			18: 10.0↔
		9: 9.7 ↗			19: 10.7x↗
		10: 10.2x↓			20: 9.9 ↖
		Serie 103.4			Serie 102.7
		Total 103.4			Total 206.1
40 Skud		21: 10.3x➤	40 Skud		31: 10.6x↔
		22: 10.0 ↑			32: 10.8x➤
		23: 10.3x➤			33: 10.3x↗
		24: 10.4x↔			34: 10.4x↓
		25: 8.8 ↗			35: 10.0↔
		26: 10.4x↗			36: 10.4x↓
		27: 10.3x↑			37: 10.4x↔
		28: 10.6x↔			38: 10.0↖
		29: 10.8x↘			39: 10.4x↓
		30: 10.6x↔			40: 10.5x↙
		Serie 102.5			Serie 103.8
		Total 308.6			Total 412.4

Hold	Skive	Karl H. Hamann	
51	8		
AAS		Trehøje	S1
Luftstævne		Aalborg Skyttekreds	
Prøve 	1: 8.6 ↖ 2: 9.4 ↑ 3: 9.4 ← 4: 10.6x↘ 5: 10.2x← 6: 10.5x↓ 7: 9.5 → 8: 10.1→ 9: 10.4x↗ 10: 10.7x> Serie 99.4 Total 0.0	Prøve 	11: 9.9 ↗ 12: 9.6 → 13: 10.4x↘ 14: 9.5 ↗ 15: 10.6x↗ 16: 9.7 ↗ Serie 59.7 Total 0.0
40 Skud 	1: 9.7 ↑ 2: 9.8 ↑ 3: 10.5x↗ 4: 10.7x> 5: 10.2x↗ 6: 10.6x> 7: 9.9 ↓ 8: 10.0 ↗ 9: 10.5x> 10: 10.4x↘ Serie 102.3 Total 102.3	40 Skud 	11: 10.3x↗ 12: 9.5 → 13: 10.9x↓ 14: 10.7x↘ 15: 10.3x↘ 16: 10.3x↘ 17: 10.1 ↗ 18: 10.4x> 19: 9.5 ↓ 20: 10.1 → Serie 102.1 Total 204.4
40 Skud 	21: 10.6x↘ 22: 9.5 → 23: 9.6 → 24: 10.3x> 25: 10.4x↗ 26: 10.6x↗ 27: 10.6x↗ 28: 10.8x> 29: 10.7x↗ 30: 10.8x> Serie 103.9 Total 308.3	40 Skud 	31: 10.3x↘ 32: 9.9 ↑ 33: 9.5 → 34: 10.2x↗ 35: 10.5x↗ 36: 10.1 ↖ 37: 9.8 ↑ 38: 10.3x> 39: 10.7x↗ 40: 10.0 ↖ Serie 101.3 Total 409.6

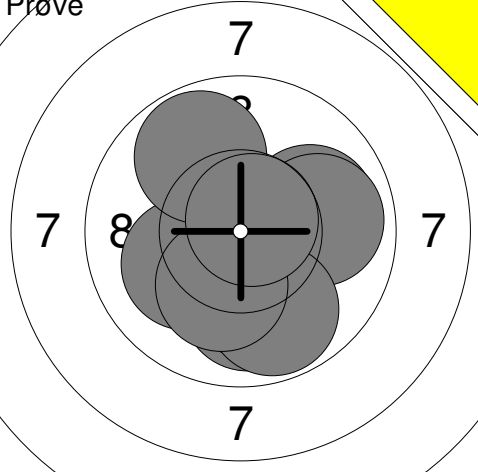
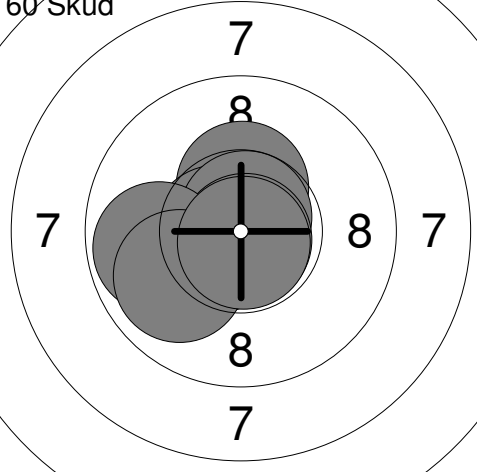
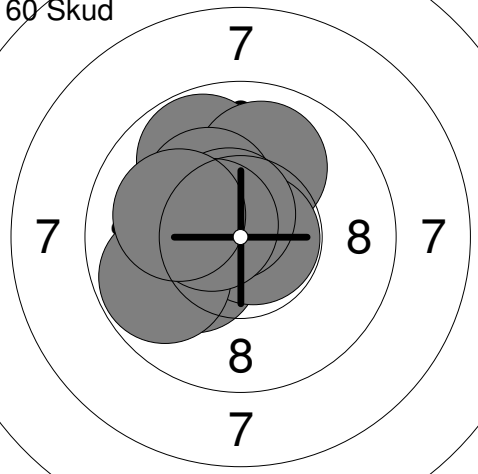
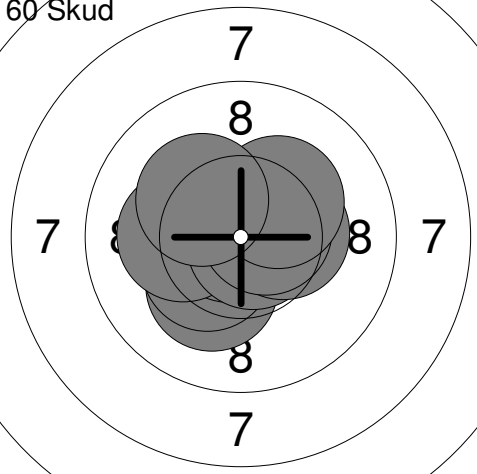
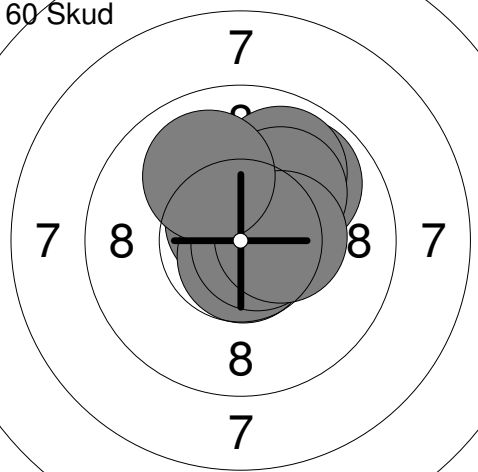
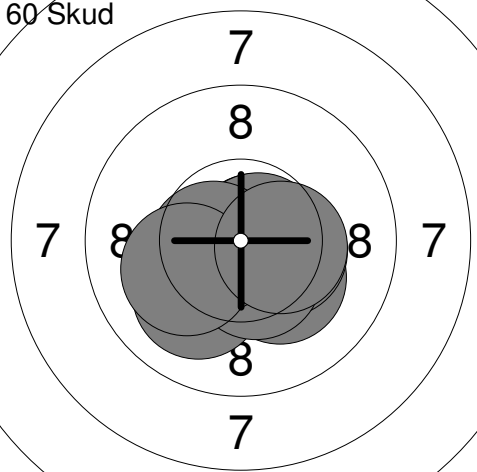
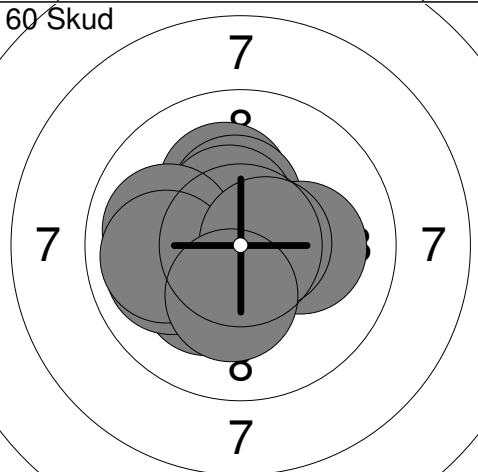
Prøve 	1: 10.0 → 2: 9.9 → 3: 10.5x ↓ 4: 10.0 ↓ 5: 10.1 ↓ 6: 9.8 ↓ 7: 10.1 ← 8: 10.2x ↓ 9: 9.8 ↑ 10: 10.7x ↗ <hr/> Serie 101.1 Total 0.0	60 Skud 	1: 10.4x ↑ 2: 10.6x ← 3: 10.9x ↓ 4: 10.6x ← 5: 10.6x ← 6: 10.7x ↑ 7: 10.8x ↓ 8: 9.8 ← 9: 9.9 ← 10: 10.8x ↓ <hr/> Serie 105.1 Total 105.1
60 Skud 	11: 10.4x ↑ 12: 9.8 ↑ 13: 10.0 ↑ 14: 10.2x ← 15: 10.2x ↑ 16: 10.8x → 17: 10.6x ↑ 18: 9.8 ← 19: 10.5x ← 20: 10.1 ← <hr/> Serie 102.4 Total 207.5	60 Skud 	21: 10.6x ↖ 22: 10.2x ↓ 23: 10.4x ← 24: 10.8x ← 25: 10.2x ← 26: 10.8x → 27: 10.4x → 28: 10.6x → 29: 10.3x ↗ 30: 10.2x ↗ <hr/> Serie 104.5 Total 312.0
60 Skud 	31: 9.9 ↗ 32: 10.4x → 33: 10.8x ↑ 34: 10.7x ↑ 35: 9.9 ↗ 36: 10.7x ↓ 37: 10.7x → 38: 10.1 ↗ 39: 10.4x → 40: 10.0 ↑ <hr/> Serie 103.6 Total 415.6	60 Skud 	41: 10.7x → 42: 10.3x ← 43: 10.0 ↓ 44: 10.2x ↓ 45: 10.4x → 46: 10.5x ↓ 47: 10.7x → 48: 10.6x ← 49: 10.1 ← 50: 10.4x → <hr/> Serie 103.9 Total 519.5
60 Skud 	51: 10.2x ↑ 52: 10.2x ↓ 53: 10.0 ← 54: 10.4x ↑ 55: 10.5x ↑ 56: 10.0 ← 57: 10.1 → 58: 9.9 ← 59: 10.6x → 60: 10.3x ↓ <hr/> Serie 102.2 Total 621.7		

Hold	Skive	Trine Klit Andersen	
51	10	AAS	Vester Hassing Skytteforening
Luftstævne		Aalborg Skyttekreds	
Prøve		1: 8.0 ↓ 2: 8.3 ↓ 3: 9.4 ↓ 4: 10.3x↗ 5: 10.4x↗ 6: 10.3x↗ 7: 9.8 ↑ 8: 10.6x↗ 9: 9.5 ← 10: 10.7x←	Prøve
		Serie 97.3	11: 10.2x← 12: 10.6x↗ 13: 10.1 ↖ 14: 10.8x↗ 15: 10.5x← 16: 10.5x← 17: 10.6x↗ 18: 10.7x↗ 19: 10.2x↗ 20: 10.1 →
		Total 0.0	Serie 104.3
			Total 0.0
Prøve		21: 10.6x↗	30 Skud
		Serie 10.6	1: 10.1 ↖ 2: 10.8x← 3: 10.3x← 4: 10.3x→ 5: 10.0 → 6: 10.5x↓ 7: 10.2x← 8: 10.9x↗ 9: 10.1 ↖ 10: 10.7x←
		Total 0.0	Serie 103.9
			Total 103.9
30 Skud		11: 10.3x← 12: 10.7x↓ 13: 10.3x↓ 14: 10.6x↗ 15: 10.8x← 16: 10.5x↓ 17: 10.7x← 18: 10.5x↗ 19: 9.5 → 20: 10.3x↘	30 Skud
		Serie 104.2	21: 10.6x→ 22: 10.3x↗ 23: 10.4x→ 24: 10.8x← 25: 10.6x↗ 26: 10.6x↗ 27: 10.3x→ 28: 10.8x→ 29: 10.6x↗ 30: 10.5x→
		Total 208.1	Serie 105.5
			Total 313.6

Hold	Skive	Daniel Larsen	
51	11		
AAS		Vester Hassing Skytteforening	U13-2
Luftstævne		Aalborg Skyttekreds	
Prøve 	1: 9.8 ↘ 2: 10.5x↓ 3: 10.1 → 4: 10.4x↓ 5: 10.2x↘ 6: 10.1 ↖ 7: 10.5x↗ 8: 10.3x→ 9: 10.6x↖ 10: 10.4x↖	Prøve 	11: 10.4x↗ 12: 10.4x↖ 13: 10.7x↗ 14: 10.1 ↖ 15: 10.3x↖ 16: 10.5x↓ 17: 10.7x↖ 18: 9.8 ↖
	Serie 102.9		Serie 82.9
	Total 0.0		Total 0.0
30 Skud 	1: 10.1 ↖ 2: 10.7x↗ 3: 9.6 ↖ 4: 10.4x↗ 5: 10.2x↗ 6: 10.5x↓ 7: 10.5x↓ 8: 10.7x↓ 9: 10.1 ↖ 10: 10.6x→	30 Skud 	11: 10.2x↗ 12: 10.1 ↑ 13: 10.8x→ 14: 10.5x→ 15: 10.1 → 16: 10.1 ↑ 17: 10.5x↖ 18: 10.1 ↑ 19: 10.6x→ 20: 10.7x↗
	Serie 103.4		Serie 103.7
	Total 103.4		Total 207.1
30 Skud 	21: 10.7x↖ 22: 10.2x→ 23: 10.3x↗ 24: 10.4x→ 25: 10.5x↖ 26: 10.6x↖ 27: 10.7x→ 28: 10.3x↗ 29: 10.8x↖ 30: 10.7x↖		
	Serie 105.2		
	Total 312.3		

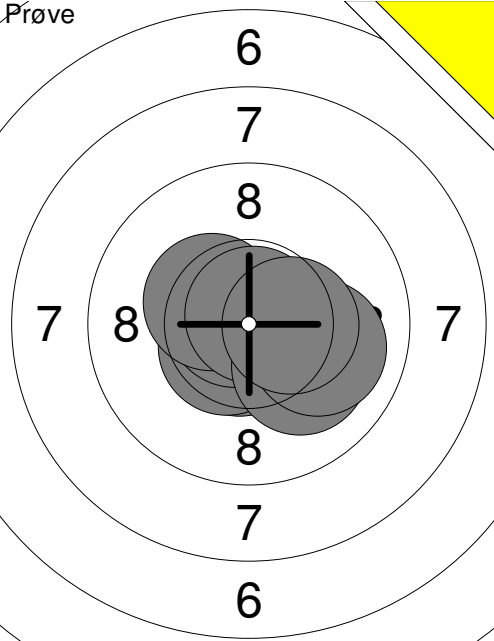
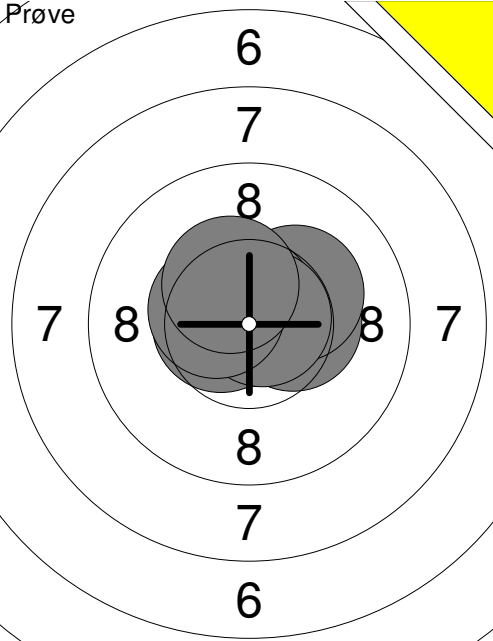
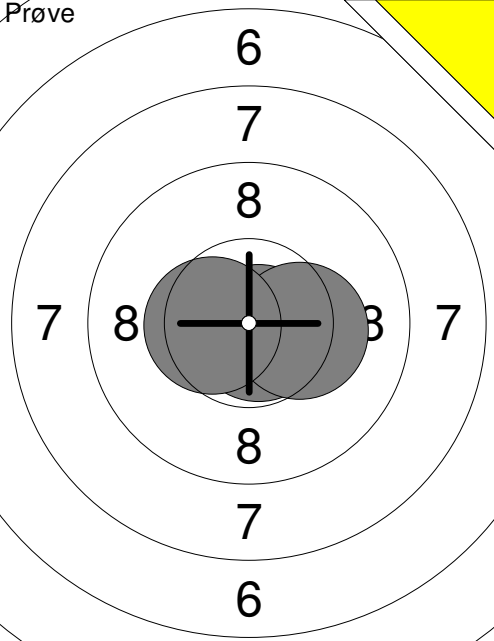
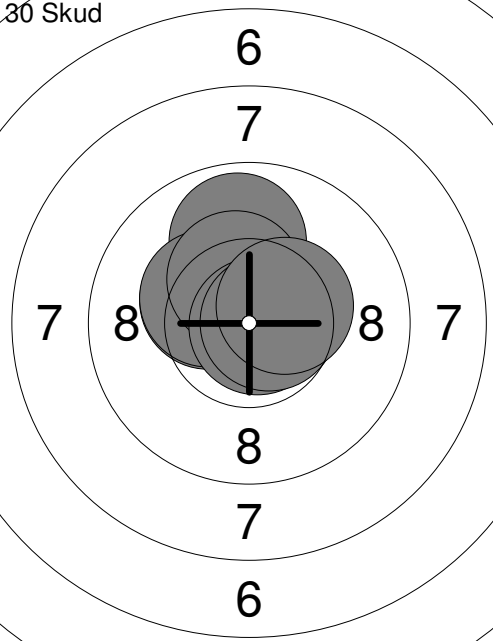
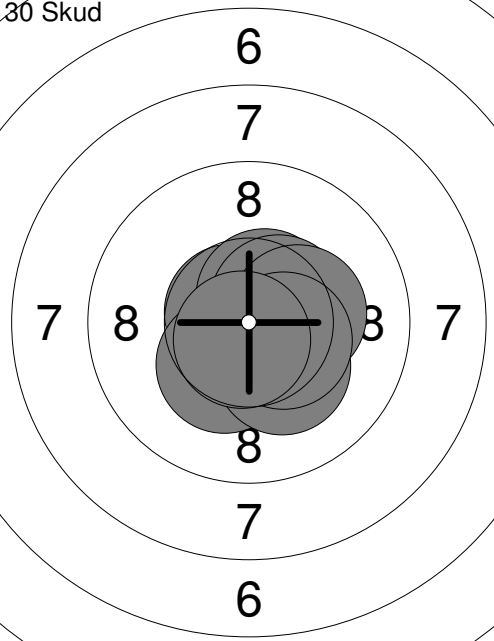
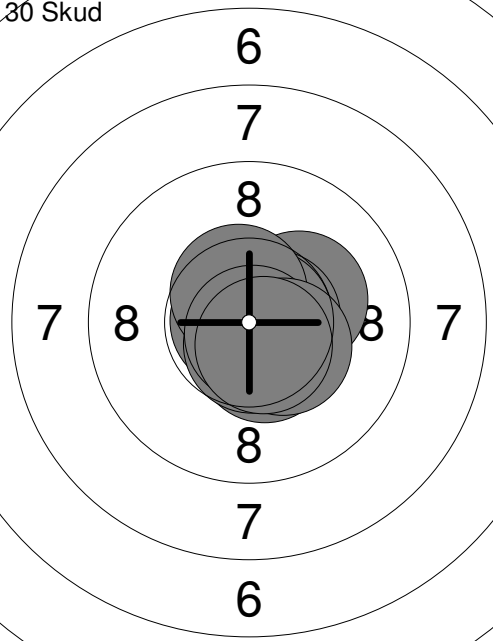
Hold	Skive	Emil Hedemann	
51	12		
AAS		Vester Hassing Skytteforening	U13-2
Luftstævne		Aalborg Skyttekreds	
Prøve		1: 10.2x↘ 2: 10.6x↘ 3: 10.2x↘ 4: 10.5x↘ 5: 10.8x↘ 6: 10.4x↘ 7: 10.8x↗ 8: 10.1 ↘ 9: 10.0 → 10: 10.4x→ Serie 104.0 Total 0.0	Prøve  11: 10.4x→ 12: 10.2x↗ 13: 10.7x↗ 14: 10.8x↗ 15: 10.7x↗ 16: 10.8x↘ 17: 10.6x↖ 18: 10.8x→ 19: 10.5x↘ 20: 10.4x↘ Serie 105.9 Total 0.0
Prøve		21: 10.8x↘ 22: 10.3x→ 23: 10.5x↖ Serie 31.6 Total 0.0	30 Skud  1: 10.7x→ 2: 10.8x↗ 3: 10.3x↘ 4: 10.7x↗ 5: 9.9 ↑ 6: 10.3x↘ 7: 10.4x↗ 8: 10.8x→ 9: 10.7x→ 10: 10.4x→ Serie 105.0 Total 105.0
30 Skud		11: 10.6x↘ 12: 10.7x↘ 13: 10.3x↘ 14: 10.2x↘ 15: 10.6x↗ 16: 10.7x→ 17: 10.5x↗ 18: 10.3x→ 19: 10.4x→ 20: 10.7x↘ Serie 105.0 Total 210.0	30 Skud  21: 10.2x→ 22: 10.6x→ 23: 10.8x↘ 24: 10.8x→ 25: 10.5x↗ 26: 10.5x↘ 27: 10.7x↘ 28: 10.8x↘ 29: 10.4x↘ 30: 10.6x↘ Serie 105.9 Total 315.9

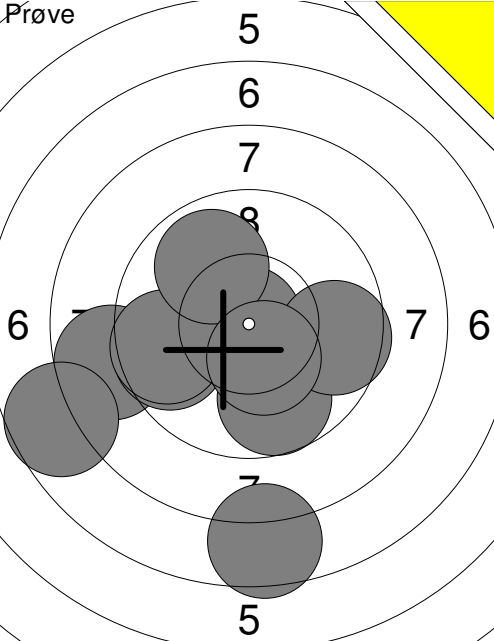
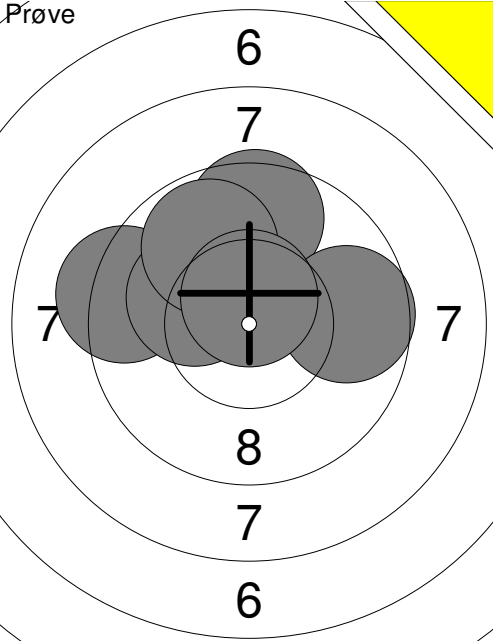
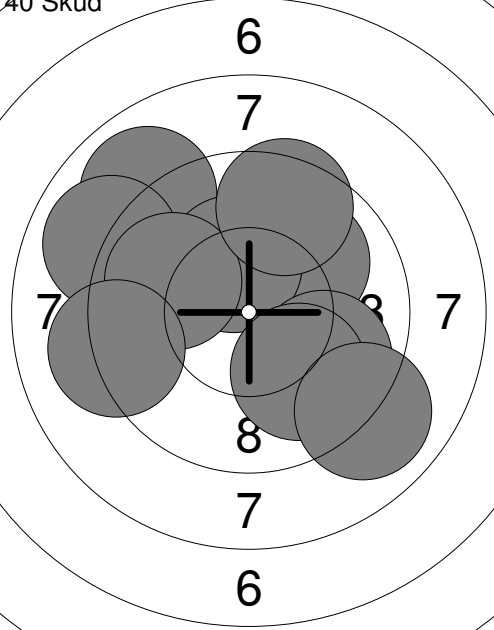
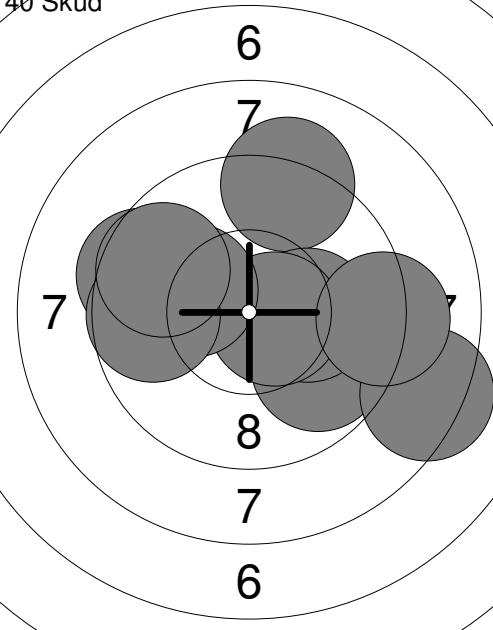
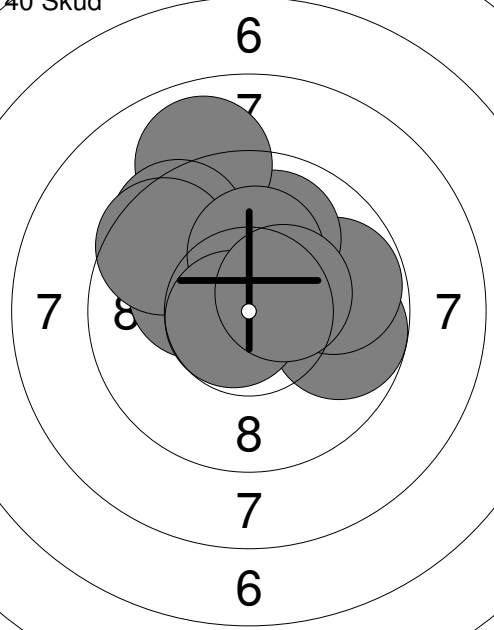
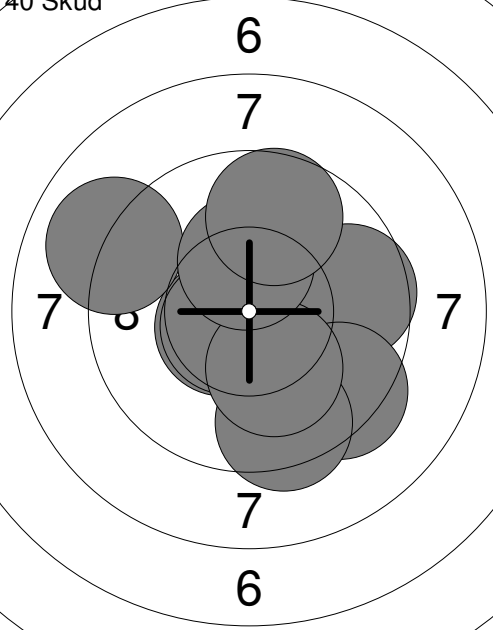
Hold	Skive	Simone Berg		D	R
52	1	Viborg Skytteforening			
AAS		Luftstævne		Aalborg Skyttekreds	
Prøve		1: 7.6 ↓ 2: 8.7 ← 3: 9.7 ↓ 4: 7.7 ← 5: 9.6 ← 6: 10.9x 7: 9.6 ← 8: 9.6 → 9: 9.9 ↗ 10: 10.4x↓	Prøve		11: 9.6 ↑ 12: 9.3 ← 13: 9.7 → 14: 10.2x 15: 9.8 ↗ 16: 10.6x↑
		Serie 93.7		Serie 59.2	
		Total 0.0		Total 0.0	
40 Skud		1: 10.0 ↗ 2: 8.9 ↗ 3: 10.3x↑ 4: 8.9 ← 5: 9.9 ← 6: 9.2 ← 7: 9.8 → 8: 9.9 ↓ 9: 9.5 ↑ 10: 9.0 ↓	40 Skud		11: 9.8 ↘ 12: 8.3 → 13: 9.2 ↑ 14: 10.2x→ 15: 10.6x→ 16: 10.1 ← 17: 9.5 ← 18: 9.7 ← 19: 9.7 ← 20: 9.2 →
		Serie 95.4		Serie 96.3	
		Total 95.4		Total 191.7	
40 Skud		21: 9.7 → 22: 10.2x 23: 9.8 → 24: 10.0 ↑ 25: 8.9 ↑ 26: 9.5 ↗ 27: 9.6 ← 28: 10.2x↑ 29: 10.7x 30: 10.4x↗	40 Skud		31: 10.6x 32: 10.3x→ 33: 9.6 → 34: 10.6x 35: 9.4 ↘ 36: 9.0 ← 37: 9.4 ↓ 38: 10.1 ↓ 39: 10.3x↑ 40: 9.7 ↑
		Serie 99.0		Serie 99.0	
		Total 290.7		Total 389.7	

Hold	Skive	Christine Jacobi	
52	2	Viborg Skytteforening	U17-1 R
AAS	Luftstævne	Aalborg Skyttekreds	
Prøve		1: 10.5x↗ 2: 9.1 ↘ 3: 9.4 → 4: 9.5 → 5: 8.4 → 6: 10.4x→ 7: 9.5 ↗ 8: 10.2x↗ 9: 9.9 ↙ 10: 9.4 → Serie 96.3 Total 0.0	Prøve 11: 10.5x→ 12: 9.6 → 13: 10.4x↗ 14: 10.3x↗ 15: 10.2x↗ 16: 10.4x↗ 17: 10.2x↘ 18: 10.4x↘ 19: 10.6x→ 20: 10.7x↘ Serie 103.3 Total 0.0
40 Skud		1: 10.0← 2: 10.2x↘ 3: 9.5 ↘ 4: 10.3x↘ 5: 10.0↘ 6: 10.6x↗ 7: 10.0→ 8: 10.1← 9: 10.6x↘ 10: 10.8x→ Serie 102.1 Total 102.1	40 Skud 11: 10.4x→ 12: 10.4x↘ 13: 10.5x↘ 14: 10.2x↘ 15: 9.9 ↗ 16: 10.9x↘ 17: 10.4x↘ 18: 10.7x↘ 19: 10.3x↘ 20: 10.6x→ Serie 104.3 Total 206.4
40 Skud		21: 10.2x↘ 22: 10.1 → 23: 10.4x↘ 24: 10.5x→ 25: 9.6 → 26: 10.4x↗ 27: 10.2x↘ 28: 10.3x↘ 29: 9.6 ↗ 30: 10.1 ↗ Serie 101.4 Total 307.8	40 Skud 31: 10.0 ↘ 32: 9.7 ← 33: 10.0 ↘ 34: 9.7 → 35: 9.4 ↘ 36: 10.4x↗ 37: 10.0↙ 38: 10.5x↘ 39: 9.9 → 40: 9.5 ← Serie 99.1 Total 406.9

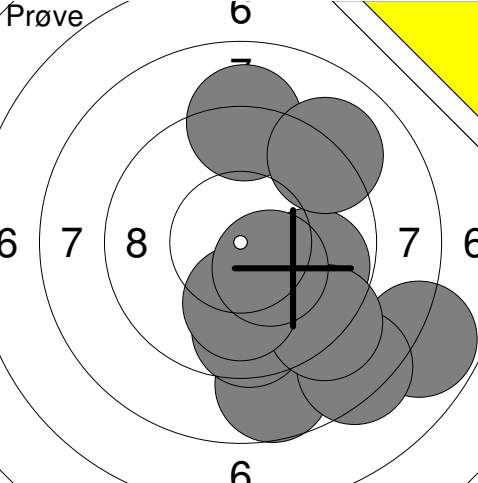
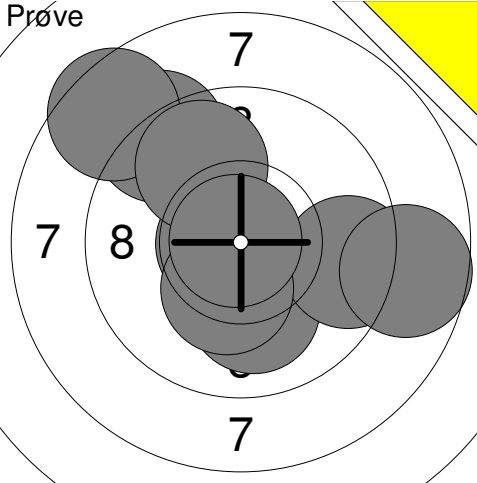
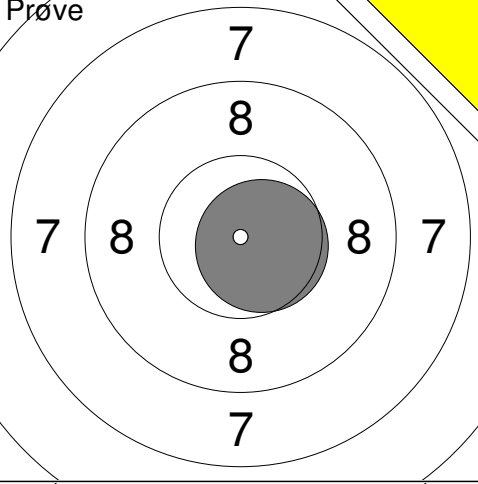
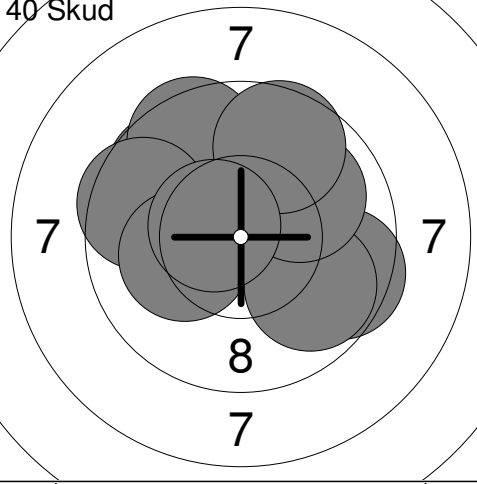
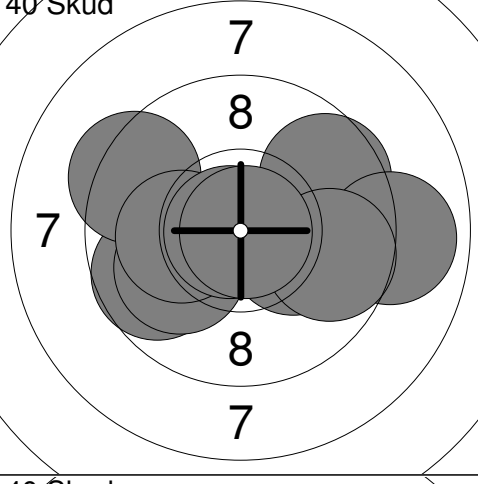
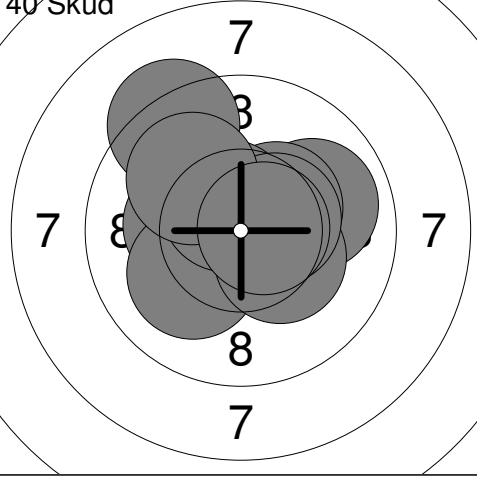
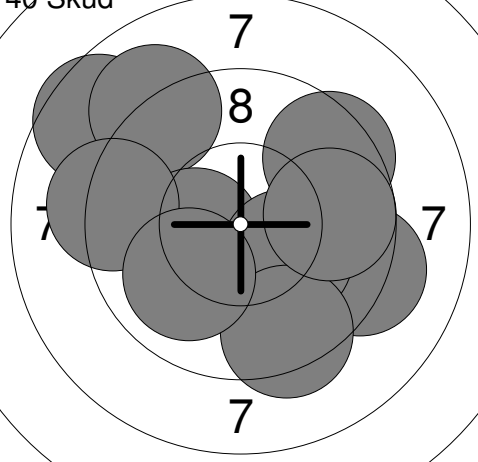
Hold 52	Skive 3	Marie Kristensen			
AAS		BPI		U15-1	R
Luftstævne		Aalborg Skyttekreds			
Prøve		1: 8.7 ↓ 2: 9.6 ↓ 3: 7.8 ↓ 4: 8.3 ↓ 5: 9.8 → 6: 9.2 ↓ 7: 10.0 ↓ 8: 10.3x ↓ 9: 9.1 ↑ 10: 9.1 ↗	Prøve		11: 10.1 ↓ 12: 9.2 ↗ 13: 9.5 → 14: 8.5 ↗ 15: 10.7x ← 16: 10.3x ↓ 17: 9.8 ↗ 18: 10.9x ← 19: 8.7 →
	Serie 91.9 Total 0.0			Serie 87.7 Total 0.0	
Prøve		21: 10.6x →	40 Skud		1: 9.7 ↗ 2: 9.5 ↗ 3: 10.2x ↗ 4: 9.5 → 5: 9.8 ↓ 6: 10.0 ↗ 7: 9.6 ← 8: 10.2x ← 9: 9.6 ↑ 10: 10.6x ↗
	Serie 10.6 Total 0.0			Serie 98.7 Total 98.7	
40 Skud		11: 9.7 ← 12: 10.0 ← 13: 9.4 ↗ 14: 10.1 ← 15: 10.2x → 16: 9.6 ↗ 17: 10.8x ← 18: 8.9 → 19: 9.7 → 20: 10.9x →	40 Skud		21: 10.2x ← 22: 9.9 → 23: 10.1 ↖ 24: 10.3x ↘ 25: 10.4x ↗ 26: 10.6x ↗ 27: 9.3 ↗ 28: 10.5x → 29: 10.0 ↗ 30: 10.6x →
	Serie 99.3 Total 198.0			Serie 101.9 Total 299.9	
40 Skud		31: 8.6 ↗ 32: 9.0 ↗ 33: 9.2 → 34: 9.5 ↗ 35: 10.3x ← 36: 9.2 ← 37: 10.2x ↓ 38: 9.4 ↓ 39: 9.7 → 40: 10.0 ↖			
	Serie 95.1 Total 395.0				

Hold	Skive	Lærke Fabricius											
52	4			BPI	U15-1 R								
AAS		Luftstævne		Aalborg Skyttekreds									
Prøve		1: 10.3x	2: 10.3x	Prøve		11: 9.6	12: 10.7x	13: 9.9	14: 9.9	15: 9.5	16: 9.4	17: 9.3	
		3: 9.7	4: 9.7			18: 9.6	19: 10.1	20: 10.4x	21: 9.7	22: 9.8	23: 10.1	24: 9.8	25: 10.2x
		5: 9.9	6: 10.0			26: 9.5	27: 9.8	28: 10.5x	29: 10.2x	30: 10.4x	31: 10.7x	32: 10.6x	33: 9.1
		7: 9.9	8: 9.3			34: 10.5x	35: 10.5x	36: 10.0	37: 10.2x	38: 10.4x	39: 10.6x	40: 9.7	
		9: 10.0	10: 10.7x			39: 10.6x	40: 9.7						
		Serie	99.8			Serie	68.3						
		Total	0.0			Total	0.0						
40 Skud		1: 9.2	2: 10.0	40 Skud		11: 9.5	12: 10.1	13: 10.4x	14: 9.6	15: 9.8	16: 10.7x	17: 10.3x	18: 10.3x
		3: 10.2x	4: 10.3x			19: 10.7x	20: 10.5x						
		5: 10.9x	6: 9.9										
		7: 9.5	8: 10.7x										
		9: 10.8x	10: 10.3x										
		Serie	101.8			Serie	101.9						
		Total	101.8			Total	203.7						
40 Skud		21: 9.7	22: 9.8	40 Skud		31: 10.7x	32: 10.6x	33: 9.1	34: 10.5x	35: 10.5x	36: 10.0	37: 10.2x	38: 10.4x
		23: 10.1	24: 9.8			39: 10.6x	40: 9.7						
		25: 10.2x	26: 9.5										
		27: 9.8	28: 10.7x										
		29: 10.5x	30: 10.4x										
		Serie	100.5			Serie	102.3						
		Total	304.2			Total	406.5						

Hold	Skive	Jonas Ø Pedersen	
52	5		
AAS		Aalborg Skyttekreds	
		U17-1	R
Luftstævne		Aalborg Skyttekreds	
Prøve		1: 10.1 ← 2: 9.7 ← 3: 9.6 ↑ 4: 10.1 ↑ 5: 9.8 ↑ 6: 9.7 ↓ 7: 9.1 → 8: 9.9 ↓ 9: 10.3x ← 10: 10.0 ↑ Serie 98.3 Total 0.0	Prøve 11: 9.7 → 12: 9.5 → 13: 9.6 ↓ 14: 10.5x ← 15: 9.2 → Serie 48.5 Total 0.0
60 Skud		1: 10.1 ← 2: 9.6 ↑ 3: 10.6x → 4: 9.3 → 5: 9.0 ↓ 6: 9.2 → 7: 9.2 → 8: 10.4x ↑ 9: 10.8x → 10: 9.3 ↑ Serie 97.5 Total 97.5	60 Skud 11: 9.9 ↑ 12: 9.5 ← 13: 8.9 ← 14: 9.8 ← 15: 9.9 ← 16: 10.3x ↑ 17: 9.9 ↓ 18: 10.5x ↓ 19: 10.2x ↓ 20: 10.0 ↓ Serie 98.9 Total 196.4
60 Skud		21: 9.4 → 22: 9.3 → 23: 10.0 ← 24: 10.0 ↑ 25: 9.3 ↓ 26: 9.8 ↑ 27: 9.9 → 28: 10.3x ↓ 29: 9.8 ↓ 30: 10.0 ↑ Serie 97.8 Total 294.2	60 Skud 31: 10.8x ↓ 32: 10.5x ↑ 33: 9.5 → 34: 9.5 ← 35: 10.3x → 36: 9.3 ← 37: 9.7 → 38: 10.2x ↓ 39: 9.5 ← 40: 10.5x ↓ Serie 99.8 Total 394.0
60 Skud		41: 9.9 ← 42: 10.6x ← 43: 9.3 ↑ 44: 9.4 ↑ 45: 10.5x ↑ 46: 10.6x ↓ 47: 10.5x ← 48: 9.9 ↑ 49: 9.6 → 50: 10.0 → Serie 100.3 Total 494.3	60 Skud 51: 10.7x ↑ 52: 9.7 ↓ 53: 10.0 → 54: 9.6 ← 55: 10.5x ↓ 56: 10.2x ↓ 57: 10.6x ← 58: 10.4x ↑ 59: 10.1 ↑ 60: 10.9x ↑ Serie 102.7 Total 597.0

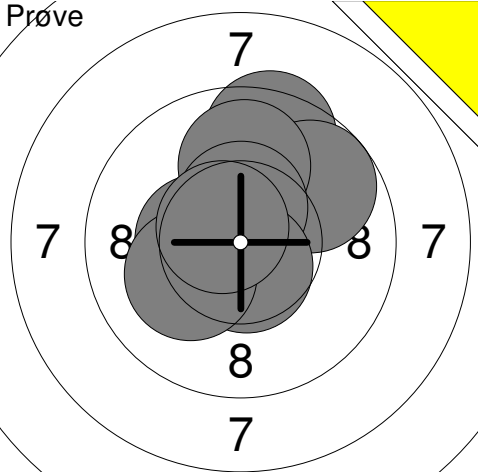
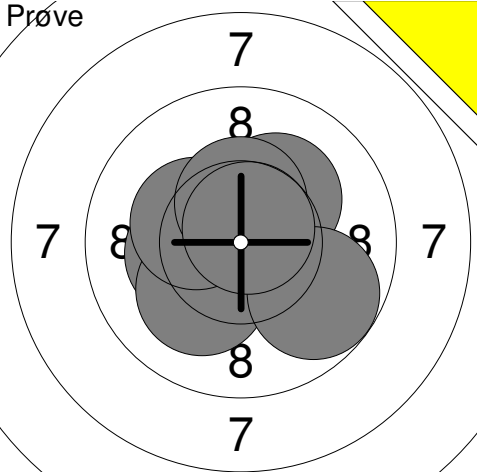
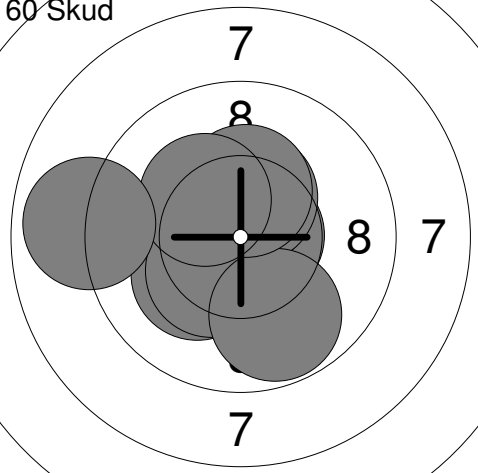
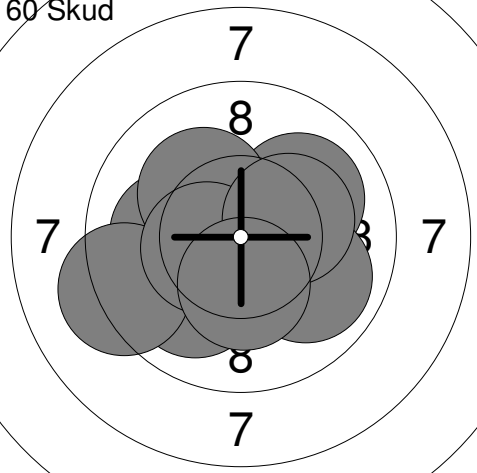
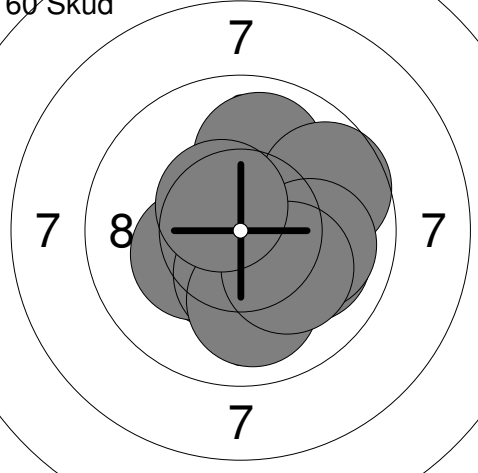
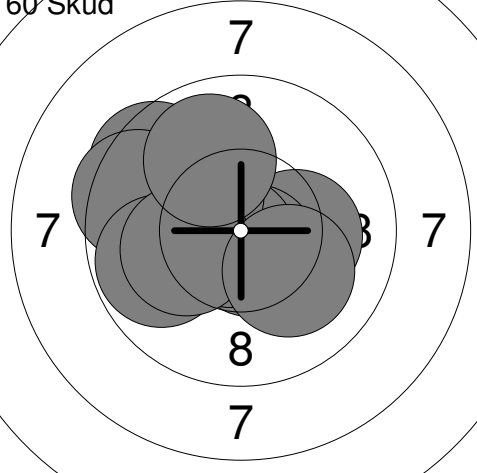
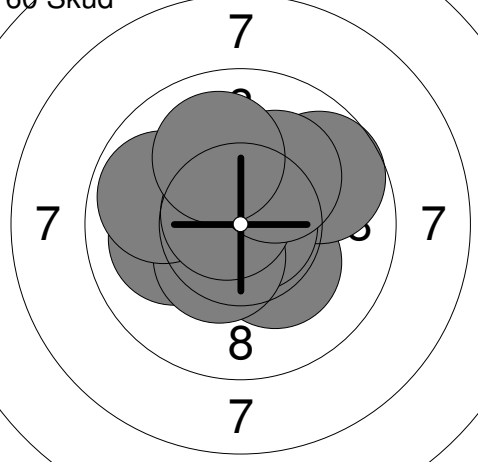
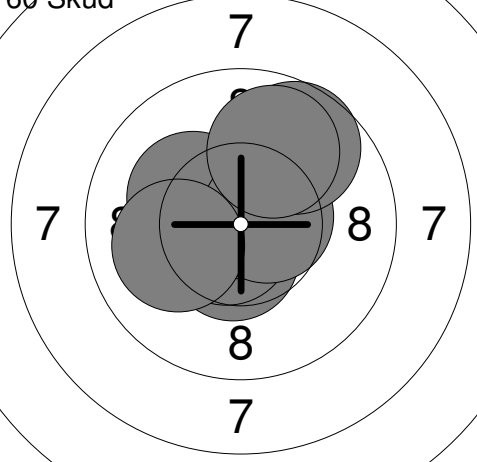
Hold	Skive	Erik Skovmand	
52	6		
AAS		Viborg Skytteforening	H R
Luftstævne		Aalborg Skyttekreds	
Prøve 	1: 9.5 ↑ 2: 10.4x ← 3: 9.8 ↗ 4: 9.9 ↑ 5: 10.9x ↘ 6: 10.5x ↘ 7: 10.5x ↑ 8: 10.6x ↓ 9: 10.1 ↘ 10: 10.6x ↖ Serie 102.8 Total 0.0	Prøve 	11: 10.5x ↗ 12: 10.2x ↗ 13: 10.3x ← 14: 10.1 ↘ 15: 9.8 ↘ 16: 10.3x ↖ 17: 10.4x ↑ 18: 10.7x ↗ Serie 82.3 Total 0.0
60 Skud 	1: 10.2x ↘ 2: 10.7x → 3: 10.6x ↑ 4: 10.5x ↑ 5: 10.4x ↑ 6: 10.4x ↘ 7: 9.8 ↘ 8: 10.3x ↑ 9: 10.3x ↗ 10: 8.9 ← Serie 102.1 Total 102.1	60 Skud 	11: 10.0 ↘ 12: 10.1 ← 13: 10.0 ↗ 14: 9.2 ↘ 15: 10.6x ↘ 16: 10.2x ↗ 17: 10.5x ← 18: 9.9 ↘ 19: 10.3x → 20: 10.3x ↓ Serie 101.1 Total 203.2
60 Skud 	21: 10.4x ↘ 22: 10.3x ← 23: 10.0 ↘ 24: 9.9 ↑ 25: 10.4x ↓ 26: 10.0 ↓ 27: 9.7 ↗ 28: 10.0 → 29: 10.1 ↘ 30: 10.5x ↗ Serie 101.3 Total 304.5	60 Skud 	31: 10.2x → 32: 9.5 ↗ 33: 10.6x ↘ 34: 10.8x ↘ 35: 10.2x ↗ 36: 9.5 ← 37: 9.8 ← 38: 10.2x ← 39: 10.1 ↘ 40: 9.9 ↗ Serie 100.8 Total 405.3
60 Skud 	41: 10.3x ↘ 42: 9.7 ↗ 43: 10.5x ↑ 44: 10.0 ← 45: 10.8x → 46: 10.4x ↘ 47: 9.8 ← 48: 10.7x ↗ 49: 10.2x ↗ 50: 10.0 ↑ Serie 102.4 Total 507.7	60 Skud 	51: 10.5x ↓ 52: 10.7x ↗ 53: 10.3x ↖ 54: 10.7x ↘ 55: 10.7x ↗ 56: 10.2x ↖ 57: 10.6x → 58: 9.7 ↗ 59: 9.9 ↗ 60: 10.1 ← Serie 103.4 Total 611.1

Hold	Skive	Caroline Jacobi	
52	7	Viborg Skytteforening	U15-1 R
AAS		Luftstævne	Aalborg Skyttekreds
Prøve		1: 9.3 ↘ 2: 9.5 ↘ 3: 9.6 → 4: 10.1 ↗ 5: 10.5x↑ 6: 9.4 ↗ 7: 8.6 ← 8: 10.0 → 9: 10.6x↖ 10: 9.8 ↖ Serie 97.4 Total 0.0	Prøve 11: 9.4 ↗ 12: 10.0 ↑ 13: 10.0 ↑ 14: 10.8x↓ 15: 9.4 → 16: 8.8 ↖ 17: 10.3x↖ 18: 10.4x↖ 19: 10.7x↓ 20: 9.9 ← Serie 99.7 Total 0.0
40 Skud		1: 9.7 ↖ 2: 10.1 ↓ 3: 9.7 ↘ 4: 10.1 ← 5: 10.8x↖ 6: 10.4x↖ 7: 9.7 ↗ 8: 10.8x→ 9: 10.4x↘ 10: 10.4x→ Serie 102.1 Total 102.1	40 Skud 11: 10.3x↓ 12: 9.8 ↖ 13: 9.9 ← 14: 10.2x↑ 15: 10.4x↖ 16: 10.5x↖ 17: 9.9 ← 18: 10.1 → 19: 10.1 ↓ 20: 10.1 ↘ Serie 101.3 Total 203.4
40 Skud		21: 10.4x↖ 22: 10.2x↑ 23: 9.2 → 24: 10.0 ← 25: 10.5x↖ 26: 10.8x↖ 27: 10.5x↓ 28: 9.9 ↖ 29: 9.6 ↗ 30: 9.9 ← Serie 101.0 Total 304.4	40 Skud 31: 10.5x↖ 32: 10.8x↖ 33: 8.8 ← 34: 10.4x↘ 35: 9.7 ↖ 36: 9.7 ↖ 37: 10.4x↑ 38: 9.8 ↖ 39: 10.1 ↓ 40: 10.5x→ Serie 100.7 Total 405.1

Hold	Skive	Emil L Nielsen	
52	8		
AAS		Aalborg Skyttekreds	
		U17-1	R
Luftstævne		Aalborg Skyttekreds	
Prøve 	1: 9.7 ↑ 2: 8.7 → 3: 9.0 ↗ 4: 10.4x ↗ 5: 9.7 → 6: 10.0 ↗ 7: 10.0 ↓ 8: 10.2x ↑ 9: 10.7x → 10: 10.5x ↑ Serie 98.9 Total 0.0	Prøve 	11: 10.1 → 12: 10.5x ↙ 13: 10.7x ← 14: 9.9 ← 15: 10.0 ↑ 16: 10.7x ↙ 17: 10.0 ↗ Serie 71.9 Total 0.0
60 Skud 	1: 10.3x ↙ 2: 9.8 ↓ 3: 10.2x ↑ 4: 9.8 ↙ 5: 9.5 ↑ 6: 10.5x ↑ 7: 10.0 ↗ 8: 10.4x ↘ 9: 10.0 → 10: 10.4x ↗ Serie 100.9 Total 100.9	60 Skud 	11: 9.4 ↙ 12: 9.4 ↘ 13: 10.5x → 14: 8.7 ↘ 15: 10.1 ↓ 16: 9.8 ↙ 17: 10.6x ↘ 18: 10.1 → 19: 10.4x ↗ 20: 9.9 → Serie 98.9 Total 199.8
60 Skud 	21: 10.4x → 22: 10.1 → 23: 10.7x ↑ 24: 9.4 ↗ 25: 10.7x ↗ 26: 10.2x ← 27: 9.6 ↓ 28: 9.3 ↑ 29: 9.9 ← 30: 10.3x ↓ Serie 100.6 Total 300.4	60 Skud 	31: 9.4 ↑ 32: 9.6 → 33: 10.3x ← 34: 10.8x ↓ 35: 9.4 ↑ 36: 10.1 → 37: 10.2x → 38: 9.7 ↓ 39: 9.7 ↘ 40: 10.2x ← Serie 99.4 Total 399.8
60 Skud 	41: 10.0 → 42: 9.4 → 43: 10.4x ↗ 44: 10.7x ↙ 45: 10.5x ↓ 46: 10.0 ↑ 47: 10.0 ↗ 48: 9.9 → 49: 10.2x → 50: 9.8 ↘ Serie 100.9 Total 500.7	60 Skud 	51: 10.2x ↑ 52: 9.7 ↙ 53: 10.6x ↑ 54: 9.6 ↗ 55: 10.5x → 56: 10.0 ↑ 57: 9.3 ↙ 58: 9.4 ↙ 59: 9.6 ← 60: 9.8 ↓ Serie 98.7 Total 599.4

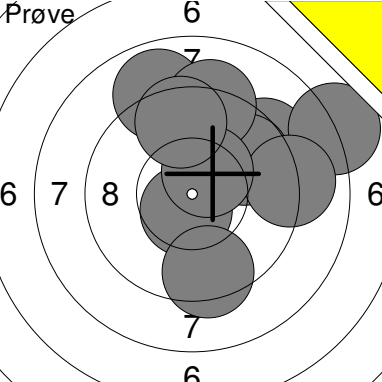
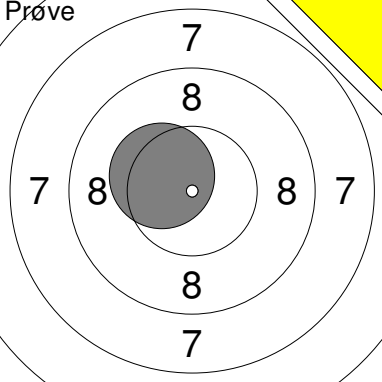
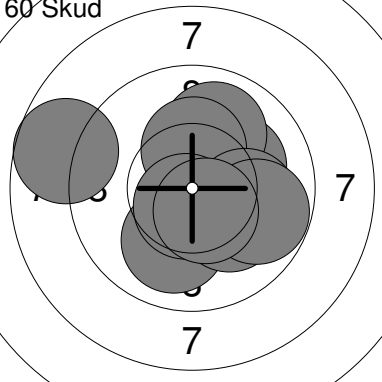
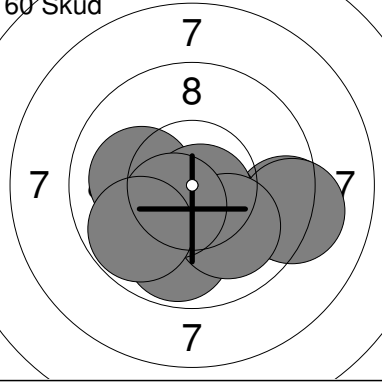
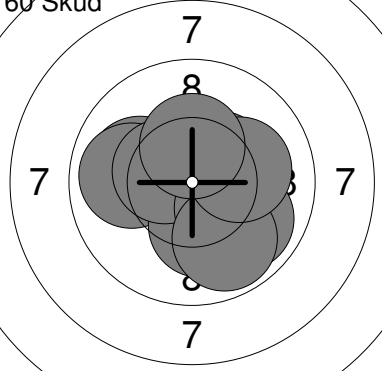
Hold	Skive	Jeppe Frost Larsen			
52	9			BPI	U17-1 R
AAS		Luftstævne		Aalborg Skyttekreds	
Prøve	6		1: 8.9 ↑ 2: 9.2 ↗ 3: 9.7 ↗ 4: 7.9 → 5: 9.0 → 6: 10.6x ↓ 7: 9.2 ↑ 8: 10.4x ↗ 9: 9.5 ↑ 10: 9.4 ↓	Prøve	11: 8.9 ↗ 12: 10.0 ↗ 13: 9.4 ↗ 14: 9.3 ↗ 16: 9.1 ↗ 17: 9.4 ← 18: 9.2 ↗ 19: 10.2x ↗ 20: 8.6 ↑
	6		Serie 93.8 Total 0.0		Serie 84.1 Total 0.0
Prøve	7		21: 10.4x ←	60 Skud	1: 9.9 → 2: 9.6 → 3: 9.8 ↑ 4: 9.7 ↗ 5: 10.5x → 6: 10.0 ↗ 7: 9.4 ↗ 8: 10.1 ↗ 9: 10.0 ↗ 10: 10.4x ↗
	7		Serie 10.4 Total 0.0		Serie 99.4 Total 99.4
60 Skud	7		11: 8.7 ← 12: 10.0 ↓ 13: 10.2x → 14: 10.0 ↗ 15: 10.3x ↑ 16: 10.0 → 17: 10.1 ↓ 18: 10.6x ↓ 19: 9.8 → 20: 10.5x ↓	60 Skud	21: 9.7 ↓ 22: 9.7 ↓ 23: 9.6 ↓ 24: 10.7x ← 25: 9.9 → 26: 9.9 ↗ 27: 10.7x ↓ 28: 10.3x ↗ 29: 9.8 ↓ 30: 9.6 ↓
	7		Serie 100.2 Total 199.6		Serie 99.9 Total 299.5
60 Skud	7		31: 10.4x ← 32: 9.3 → 33: 10.1 ← 34: 10.5x ↓ 35: 9.2 → 36: 9.8 ↓ 37: 10.7x ↓ 38: 10.0 ↓ 39: 10.5x ↓ 40: 9.8 ←	60 Skud	41: 10.4x ↑ 42: 10.7x ↓ 43: 10.5x ↑ 44: 9.6 ↗ 45: 10.3x ↓ 46: 9.2 ↗ 47: 10.6x ← 48: 10.3x → 49: 9.0 ← 50: 10.4x ↓
	7		Serie 100.3 Total 399.8		Serie 101.0 Total 500.8
60 Skud	7		51: 10.0 ← 52: 9.9 ← 53: 10.2x ↓ 54: 10.4x ↗ 55: 10.4x ↗ 56: 10.2x ↓ 57: 9.9 ↓ 58: 9.8 ↓ 59: 10.1 → 60: 10.3x ↑		
	7		Serie 101.2 Total 602.0		

Hold	Skive	Emma Kristensen	
52	10		
AAS		Vester Hassing Skytteforening	U13-2 R
Luftstævne		Aalborg Skyttekreds	
Prøve 	1: 9.7 ↙ 2: 9.5 ↓ 3: 9.3 ↓ 4: 9.4 → 5: 9.8 → 6: 10.5x → 7: 10.1 → 8: 10.5x → 9: 10.0 ↓ 10: 10.0 → Serie 98.8 Total 0.0	Prøve 	11: 10.3x ↓ 12: 10.5x ↓ 13: 9.8 ↙ 14: 10.7x → 15: 10.7x ← 16: 9.9 ↙ 17: 10.3x → 18: 10.0 → 19: 10.7x ↑ 20: 10.6x ↑ Serie 103.5 Total 0.0
Prøve 	21: 9.7 ↗ 22: 10.6x ↑ 23: 10.9x → 24: 10.6x → 25: 10.1 ↗ 26: 10.9x ↓ 27: 10.1 → 28: 10.4x → 29: 10.2x → 30: 10.7x ↗ Serie 104.2 Total 0.0	Prøve 	31: 10.7x ↓ 32: 10.0 ↗ Serie 20.7 Total 0.0
30 Skud 	1: 10.4x ↑ 2: 10.8x ← 3: 10.4x → 4: 10.2x ↗ 5: 10.4x ↑ 6: 10.6x ↗ 7: 10.4x ← 8: 10.8x ↗ 9: 10.6x ↗ 10: 10.1 ← Serie 104.7 Total 104.7	30 Skud 	11: 10.8x ← 12: 10.5x ← 13: 10.6x ↑ 14: 10.3x ↓ 15: 10.4x ↓ 16: 10.2x ↙ 17: 10.7x ↗ 18: 10.4x → 19: 10.6x ↗ 20: 10.7x ↑ Serie 105.2 Total 209.9
30 Skud 	21: 10.0 ↓ 22: 10.4x ↗ 23: 10.4x ↗ 24: 10.8x ↓ 25: 10.8x → 26: 10.6x → 27: 10.3x ↗ 28: 9.8 ↓ 29: 10.1 ← 30: 10.9x ← Serie 104.1 Total 314.0		

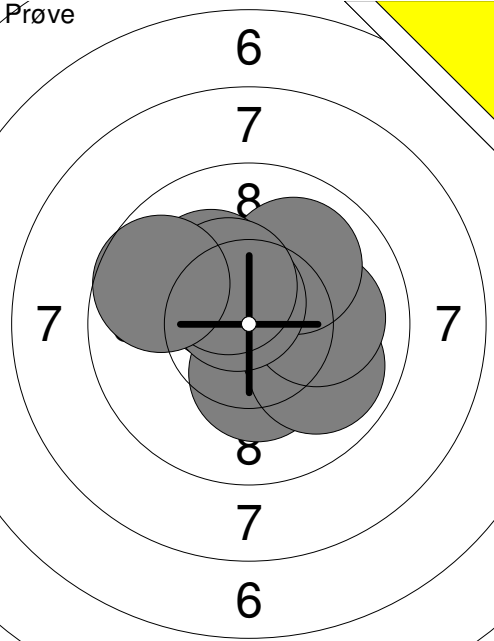
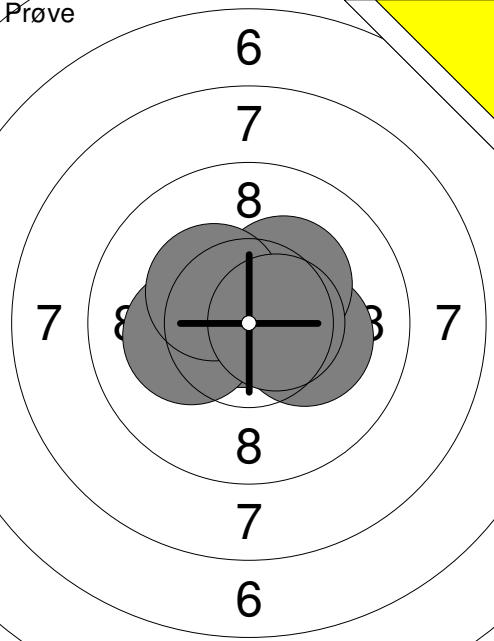
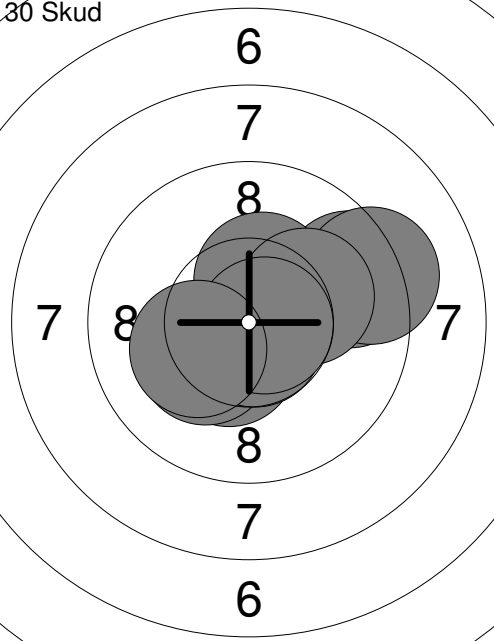
Hold	Skive	Simon Houen Jensen	
52	11	Vester Hassing Skytteforening	U13-2 R
Luftstævne		Aalborg Skyttekreds	
Prøve		1: 10.3x↓ 2: 10.1→ 3: 9.9↘ 4: 10.1→ 5: 10.0↗ 6: 10.2x↖ 7: 10.5x↖ 8: 10.6x↖ 9: 10.4x↖ 10: 9.7←	Prøve
		Serie 101.8	11: 10.3x↖
		Total 0.0	12: 9.8→
			13: 10.5x↗
			14: 10.7x↑
			15: 10.2x↖
			16: 10.7x↑
			17: 10.0←
			18: 10.5x↗
			19: 10.4x↖
			20: 10.5x↖
			Serie 103.6
			Total 0.0
Prøve		21: 10.2x↘ 22: 10.8x↖ 23: 10.7x↖ 24: 10.3x↗ 25: 10.2x↖ 26: 10.3x↖ 27: 10.6x→	30 Skud
		Serie 73.1	1: 10.5x↖
		Total 0.0	2: 10.6x↘
			3: 10.4x↗
			4: 10.3x↑
			5: 10.0↓
			6: 10.9x↓
			7: 10.9x↗
			8: 10.6x↖
			9: 10.3x→
			10: 10.5x↓
			Serie 105.0
			Total 105.0
30 Skud		11: 9.5→ 12: 9.2→ 13: 10.5x↗ 14: 10.4x↓ 15: 10.4x↑ 16: 10.1→ 17: 10.2x↖ 18: 10.7x↓ 19: 10.7x→ 20: 10.2x↖	30 Skud
		Serie 101.9	21: 9.6→
		Total 206.9	22: 10.3x↓
			23: 10.3x↖
			24: 10.6x↖
			25: 10.6x↓
			26: 10.3x↑
			27: 10.6x↓
			28: 10.2x↖
			29: 10.2x↓
			30: 10.5x↑
			Serie 103.2
			Total 310.1

Hold	Skive	Kasper Rosenmeier Jensen			
52	12	Vester Hassing Skytteforening		U13-2	R
AAS		Luftstævne		Aalborg Skyttekreds	
Prøve		1: 8.5 ↓	Prøve		11: 10.6x↗
		2: 10.4x↗			12: 10.3x>
		3: 10.0↗			13: 10.8x↗
		4: 10.6x↑			14: 9.3 ←
		5: 9.8 >			15: 10.1 ↓
		6: 8.7 >			16: 10.5x↘
		7: 10.4x↘			17: 10.1 ←
		8: 10.3x↘			18: 10.1 ↓
		9: 10.1 ←			19: 10.3x↘
		10: 9.6 ↓			20: 10.5x↘
		Serie 98.4			Serie 102.6
		Total 0.0			Total 0.0
Prøve		21: 10.3x↗	30 Skud		1: 10.6x↘
		22: 10.0 ↗			2: 10.8x↓
		23: 10.1 ↑			3: 10.2x↘
		24: 10.5x↗			4: 10.9x↘
		25: 10.2x>			5: 10.5x>
		26: 10.2x>			6: 10.3x>
		Serie 61.3			7: 9.3 ←
		Total 0.0			8: 10.3x↘
					9: 10.7x↓
					10: 10.1 →
					Serie 103.7
					Total 103.7
30 Skud		11: 10.4x↘	30 Skud		21: 10.4x↓
		12: 10.6x↘			22: 10.5x↓
		13: 10.3x↘			23: 10.6x>
		14: 9.2 >			24: 10.3x↑
		15: 9.7 >			25: 10.3x↘
		16: 10.5x↗			26: 10.0 →
		17: 10.5x↑			27: 9.8 ←
		18: 10.5x>			28: 10.3x↘
		19: 9.5 ↑			29: 9.6 →
		20: 10.2x↘			30: 10.5x↗
		Serie 101.4			Serie 102.3
		Total 205.1			Total 307.4

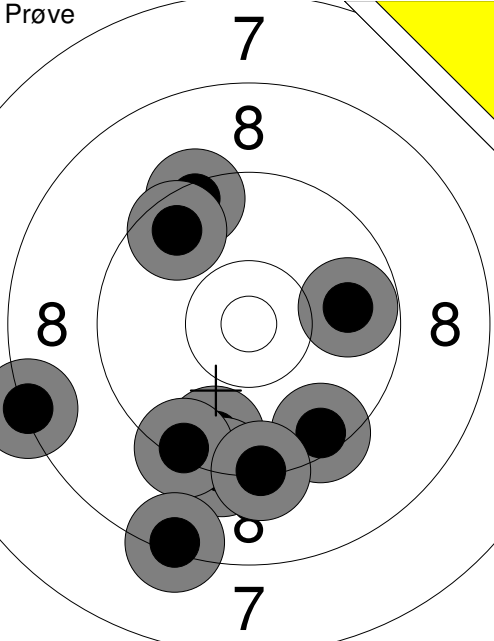
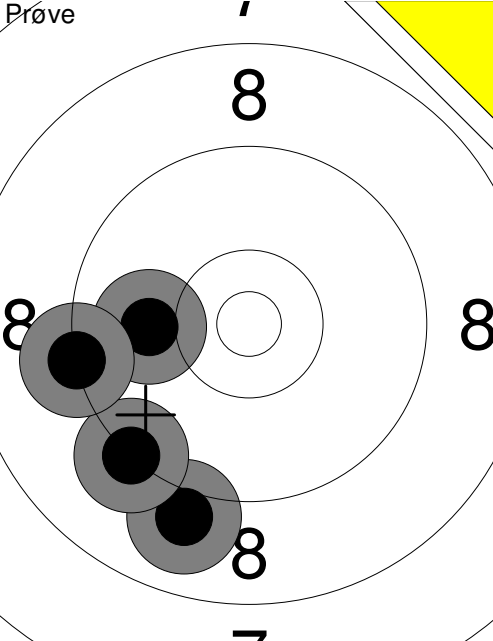
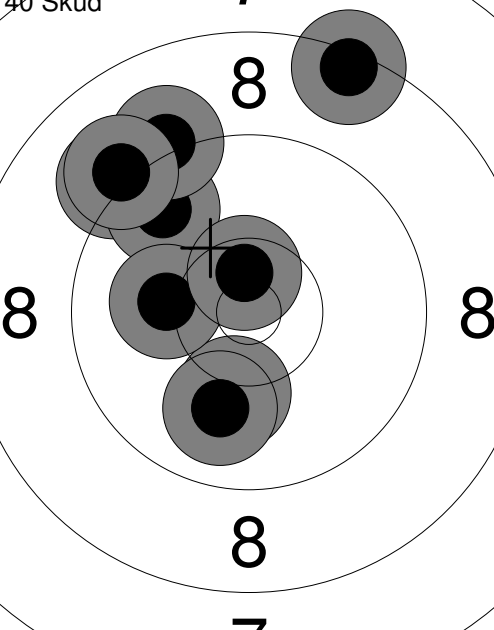
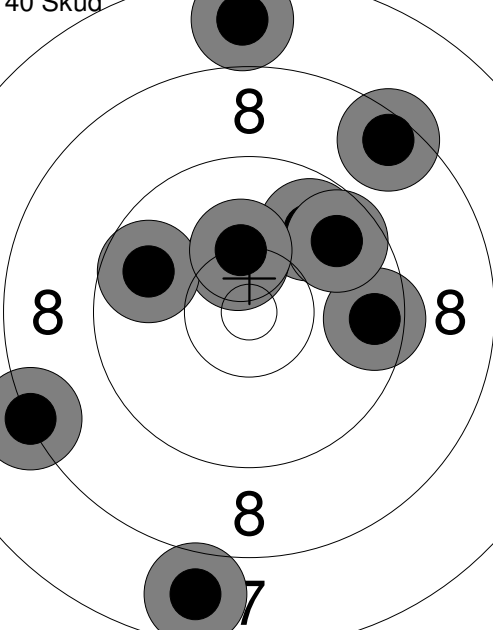
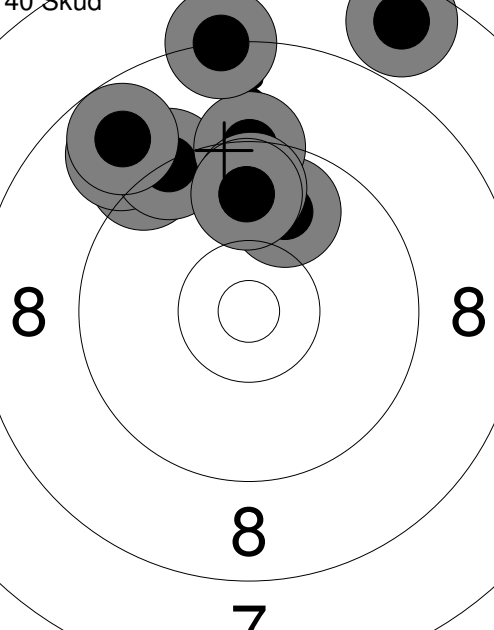
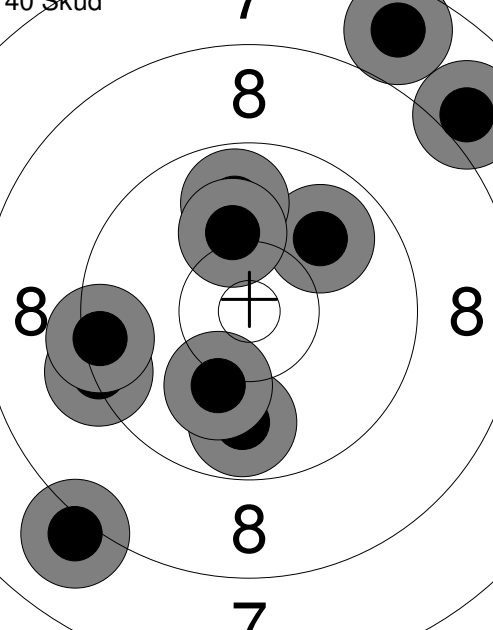
Hold	Skive	Christinna Popp Hansen		D	P
53	1				
AAS		Trehøje			
Luftstævne		Aalborg Skyttekreds			
Prøve		1: 9.6 ↓ 2: 9.8 → 3: 8.3 ← 4: 9.4 ↑ 5: 9.3 ↓ 6: 9.5 ↓ 7: 9.6 ↑ 8: 9.4 ↓ 9: 8.3 ↓ 10: 9.3 ↓	Prøve		11: 10.0 ← 12: 9.0 ↓ 13: 9.2 ↓ 14: 9.2 ←
		Serie 88.0			Serie 37.0
		Total 0.0			Total 0.0
40 Skud		1: 10.2 ↓ 2: 9.1 ↖ 3: 9.7 ↖ 4: 9.1 ↖ 5: 10.1 ← 6: 0.0 7: 10.6x ↑ 8: 10.0 ↓ 9: 9.1 ↖ 10: 8.4 ↗	40 Skud		11: 9.6 → 12: 9.8 ↗ 13: 8.5 ↗ 14: 10.4 ↑ 15: 8.3 ← 16: 7.8 ↓ 17: 9.8 ← 18: 9.7 ↗ 19: 10.3 ↑ 20: 7.7 ↑
		Serie 84.0			Serie 86.0
		Total 84.0			Total 170.0
40 Skud		21: 9.2 ↖ 22: 9.9 ↗ 23: 8.9 ↖ 24: 7.6 ↗ 25: 9.3 ↖ 26: 9.3 ↑ 27: 8.2 ↑ 28: 9.7 ↑ 29: 9.8 ↑ 30: 8.8 ↖	40 Skud		31: 9.9 ↗ 32: 9.8 ↓ 33: 9.8 ↑ 34: 8.1 ↓ 35: 10.1 ↓ 36: 9.3 ← 37: 8.0 ↗ 38: 9.4 ← 39: 10.1 ↑ 40: 7.7 ↗
		Serie 85.0			Serie 88.0
		Total 255.0			Total 343.0

Hold	Skive	Allan Borg		H	P
53	2	Års Skytteforening			
AAS		Luftstævne		Aalborg Skyttekreds	
Prøve		1: 9.3 ↑ 2: 10.3 ↓ 3: 10.1 ↗ 4: 10.0 → 5: 9.0 ← 6: 7.9 ↗ 7: 9.8 ↗ 8: 10.6x ↓ 9: 9.2 ↓ 10: 9.3 ←	Prøve		11: 9.3 → 12: 9.8 ↗ 13: 10.1 ↗ 14: 10.3 ← 15: 9.9 ↑
		Serie 92.0		Serie 47.0	
		Total 0.0		Total 0.0	
60 Skud		1: 8.7 ← 2: 9.7 → 3: 10.0 ← 4: 9.8 ↗ 5: 10.4x → 6: 8.1 ← 7: 9.0 ← 8: 9.8 ↓ 9: 10.5x ↗ 10: 10.3 ↗	60 Skud		11: 9.5 ↗ 12: 10.0 ↗ 13: 8.6 → 14: 10.0 ↗ 15: 10.1 ↓ 16: 9.8 ↓ 17: 9.2 → 18: 9.7 ↓ 19: 10.4x → 20: 10.4x ↗
		Serie 92.0		Serie 94.0	
		Total 92.0		Total 186.0	
60 Skud		21: 8.2 ↗ 22: 9.6 ↗ 23: 10.5x ↓ 24: 10.5x → 25: 9.5 → 26: 9.5 ↓ 27: 9.2 ↗ 28: 9.0 ← 29: 10.6x → 30: 10.5x ↗	60 Skud		31: 7.7 ↓ 32: 10.6x ← 33: 9.9 ↗ 34: 9.4 ↓ 35: 9.8 ↓ 36: 10.1 ↓ 37: 10.3 → 38: 9.1 ← 39: 10.1 ↗ 40: 7.4 ←
		Serie 93.0		Serie 90.0	
		Total 279.0		Total 369.0	
60 Skud		41: 9.3 ↓ 42: 8.5 ↓ 43: 10.4x ↓ 44: 10.0 ↗ 45: 8.8 ↓ 46: 10.4x ↓ 47: 10.0 ↓ 48: 9.9 ← 49: 9.8 ↗ 50: 9.3 ↗	60 Skud		51: 9.8 ↓ 52: 10.3 ← 53: 9.7 ↗ 54: 9.9 ↗ 55: 7.6 ↓ 56: 10.2 ↗ 57: 9.9 ↗ 58: 9.6 → 59: 9.3 → 60: 9.8 ↓
		Serie 92.0		Serie 90.0	
		Total 461.0		Total 551.0	

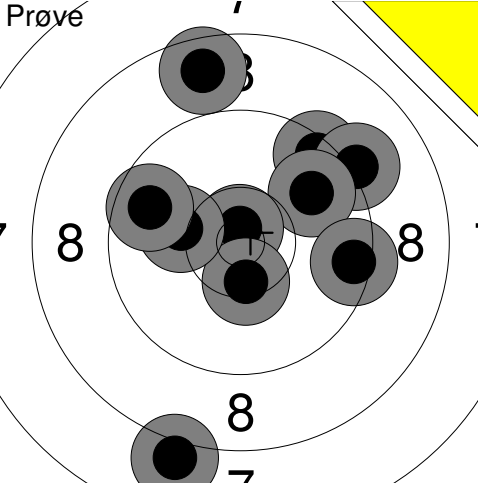
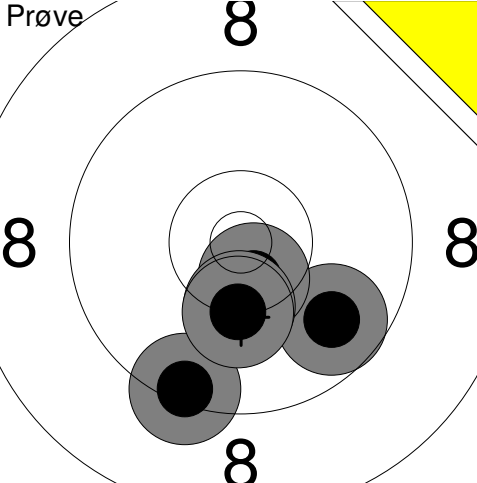
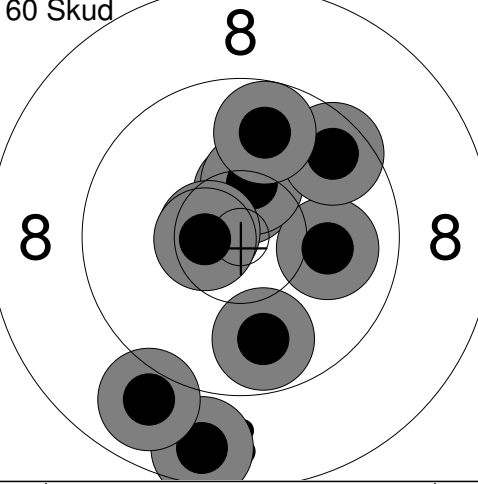
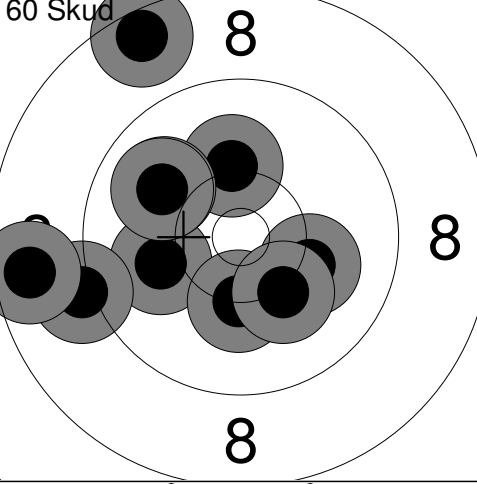
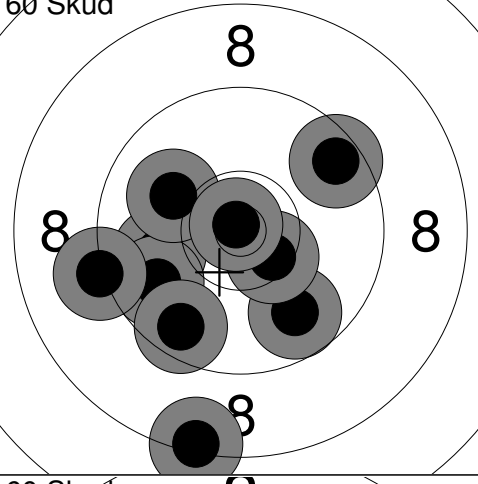
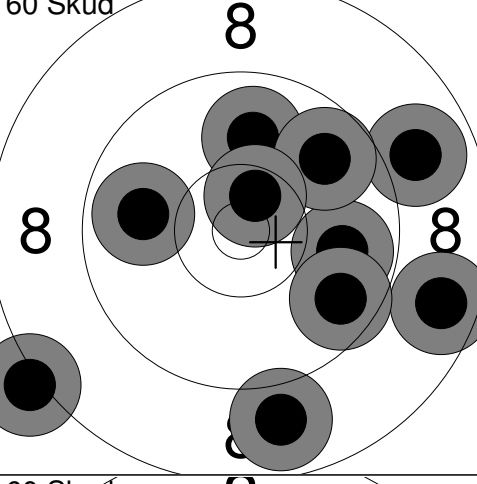
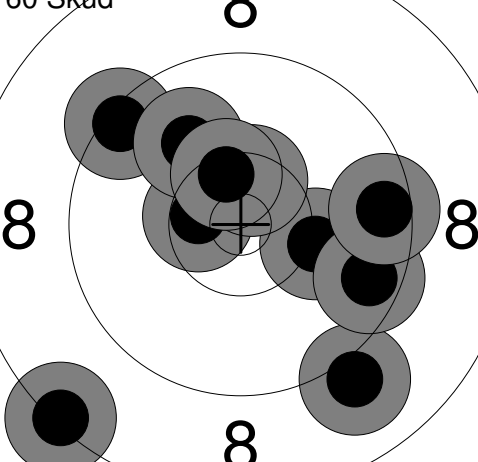
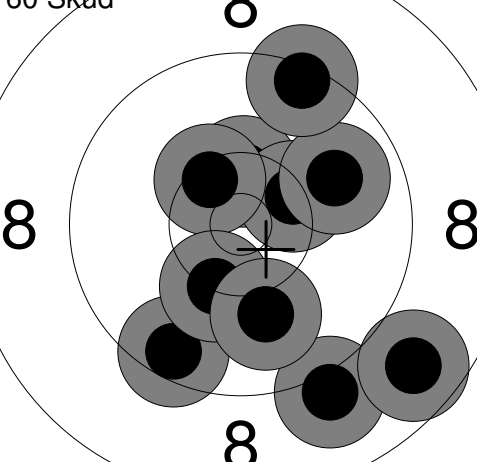
Hold	Skive	Maria Kristensen		D	P
AAS		Års Skytteforening			
Luftstævne		Aalborg Skyttekreds			
Prøve		1: 9.4 ↗ 2: 8.7 ↗ 3: 9.2 ↗ 4: 9.8 ↗ 5: 10.8x ↗ 6: 8.0 ↘ 7: 10.4x ↘ 8: 10.2 ↖ 9: 9.7 ↖ 10: 9.5 →	Prøve		11: 9.8 ↘ 12: 10.6x ↘ 13: 9.4 ↘ 14: 10.3 ↘ 15: 10.3 ↘
		Serie 91.0 Total 0.0			Serie 48.0 Total 0.0
60 Skud		1: 10.5x ↑ 2: 10.0 → 3: 10.4x ↑ 4: 9.6 ↗ 5: 8.6 ↘ 6: 8.9 ↘ 7: 9.8 ↗ 8: 9.8 ↘ 9: 10.6x ← 10: 10.6x ←	60 Skud		11: 8.5 ↗ 12: 10.0 ← 13: 10.2 ↑ 14: 10.0 ↗ 15: 10.3 ↘ 16: 9.1 ← 17: 10.1 → 18: 9.9 ↗ 19: 8.6 ← 20: 10.2 ↘
		Serie 93.0 Total 93.0			Serie 94.0 Total 187.0
60 Skud		21: 9.9 ← 22: 9.8 ← 23: 9.5 ↗ 24: 9.8 ↘ 25: 10.5x ↘ 26: 10.0 ↗ 27: 10.9x ↗ 28: 9.6 ↘ 29: 9.2 ← 30: 8.3 ↘	60 Skud		31: 9.9 ← 32: 8.9 → 33: 8.9 ↘ 34: 9.9 ↑ 35: 9.8 → 36: 8.6 → 37: 8.1 ↘ 38: 9.6 ↘ 39: 9.8 ↗ 40: 10.5x ↑
		Serie 92.0 Total 279.0			Serie 87.0 Total 366.0
60 Skud		41: 9.0 ↘ 42: 10.2 → 43: 10.5x ← 44: 10.5x ↑ 45: 9.4 ↗ 46: 10.0 ↗ 47: 10.4x ↗ 48: 9.6 ↘ 49: 8.3 ↘ 50: 9.5 →	60 Skud		51: 10.4x ↑ 52: 9.0 ↘ 53: 10.4x ↗ 54: 9.9 ↗ 55: 10.4x ↗ 56: 9.5 ↘ 57: 10.3 ↘ 58: 9.4 ↗ 59: 10.0 ↘ 60: 8.7 ↘
		Serie 94.0 Total 460.0			Serie 94.0 Total 554.0

Hold	Skive	Morten Bjørn		H	R
AAS		Viborg Skytteforening			
		Luftstævne		Aalborg Skyttekreds	
Prøve		1: 9.9 ↗ 2: 9.9 ↗ 3: 9.4 ↗ 4: 9.4 ↖ 5: 10.1 ↖ 6: 10.3x ↗ 7: 10.5x ↖ 8: 9.0 ↖ 9: 10.7x ↗ 10: 9.7 ↖	Prøve	11: 10.1 ↖ 12: 10.4x → 13: 8.3 → 14: 10.3x ↗ 15: 10.4x ↓ 16: 10.5x → 17: 10.1 ↖ 18: 10.7x ↓ 19: 9.7 ↘ 20: 9.8 ↖	
		Serie 98.9 Total 0.0		Serie 100.3 Total 0.0	
Prøve		21: 10.5x ↖ 22: 10.2x ↓	60 Skud	1: 9.6 ↓ 2: 9.7 → 3: 9.8 ↗ 4: 10.3x ↓ 5: 10.1 ↓ 6: 10.1 → 7: 10.5x → 8: 9.7 ↖ 9: 10.6x → 10: 9.6 ↖	
		Serie 20.7 Total 0.0		Serie 100.0 Total 100.0	
60 Skud		11: 10.2x ↓ 12: 9.7 ↖ 13: 9.9 ↘ 14: 10.8x ↖ 15: 9.9 → 16: 9.9 ↘ 17: 10.0 → 18: 9.6 ↘ 19: 9.6 → 20: 9.7 ↗	60 Skud	21: 9.9 ↖ 22: 9.4 → 23: 9.2 ↗ 24: 9.8 ↗ 25: 10.3x ↗ 26: 10.1 → 27: 10.4x ↗ 28: 10.3x ↗ 29: 9.5 → 30: 9.6 →	
		Serie 99.3 Total 199.3		Serie 98.5 Total 297.8	
60 Skud		31: 10.4x → 32: 9.8 ↗ 33: 9.3 → 34: 9.4 → 35: 10.0 ↓ 36: 10.7x ↗ 37: 10.4x ↘ 38: 10.4x ↘ 39: 9.9 ↗ 40: 9.7 ↖	60 Skud	41: 10.5x ↓ 42: 10.4x ↖ 43: 10.6x ↗ 44: 10.2x ↖ 45: 10.5x ↖ 46: 10.6x ↖ 47: 9.4 ↖ 48: 9.6 ↘ 49: 10.5x ↖ 50: 9.9 ↖	
		Serie 100.0 Total 397.8		Serie 102.2 Total 500.0	
60 Skud		51: 10.5x ↓ 52: 10.0 ↖ 53: 10.4x ↘ 54: 10.6x ↘ 55: 9.7 ↘ 56: 9.5 ↘ 57: 10.3x ↖ 58: 10.5x ↖ 59: 9.5 ↖ 60: 10.5x ↖			
		Serie 101.5 Total 601.5			

Hold	Skive	Kristian Møller Kristensen	
53	6		
AAS		Aalborg Skyttekreds	
		HJ	R
Luftstævne		Aalborg Skyttekreds	
Prøve		1: 9.0 → 2: 9.5 ↑ 3: 9.0 → 4: 10.6x ↓ 5: 9.5 → 6: 10.9x ↓ 7: 8.2 → 8: 9.8 ↓ 9: 9.7 → 10: 10.2x ← Serie 96.4 Total 0.0	Prøve
			11: 9.9 → 12: 10.0 → 13: 10.5x → 14: 8.7 ↓ 15: 9.7 ↓ 16: 10.1 ↓ 17: 10.7x → 18: 9.9 ↓ 19: 10.1 → 20: 10.3x ↓ Serie 99.9 Total 0.0
60 Skud		1: 10.0 → 2: 10.2x ↓ 3: 9.9 ↓ 4: 9.3 ↑ 5: 10.7x → 6: 9.2 ← 7: 10.2x ↑ 8: 10.0 → 9: 8.6 ← 10: 10.3x ↑ Serie 98.4 Total 98.4	60 Skud
			11: 9.8 ↑ 12: 9.4 ↑ 13: 9.9 ↑ 14: 10.3x ↓ 15: 10.1 → 16: 9.8 ↑ 17: 10.3x ↑ 18: 9.9 ↑ 19: 10.1 ↓ 20: 9.7 ↑ Serie 99.3 Total 197.7
60 Skud		21: 9.9 ↓ 22: 10.6x → 23: 9.9 ↓ 24: 10.5x → 25: 10.7x ↓ 26: 10.3x ↑ 27: 10.5x → 28: 9.6 ↓ 29: 10.1 ← 30: 10.1 ↑ Serie 102.2 Total 299.9	60 Skud
			31: 10.6x ↑ 32: 10.2x → 33: 9.8 ← 34: 9.7 ← 35: 10.3x ↑ 36: 9.2 ← 37: 8.9 → 38: 10.3x ↑ 39: 9.1 → 40: 9.9 ↑ Serie 98.0 Total 397.9
60 Skud		41: 9.8 → 42: 9.4 → 43: 10.2x ← 44: 10.4x ↓ 45: 9.5 ↓ 46: 10.2x → 47: 10.3x → 48: 9.6 ↑ 49: 8.9 → 50: 10.1 ↓ Serie 98.4 Total 496.3	60 Skud
			51: 10.8x ↓ 52: 9.5 ← 53: 9.6 ↓ 54: 10.7x ↓ 55: 9.7 ↑ 56: 9.0 ↑ 57: 10.3x → 58: 9.9 ↓ 59: 9.8 ← 60: 10.3x ↑ Serie 99.6 Total 595.9

Hold	Skive	Nickolai Malte Kristensen			
53	7	AAS		ÅRK	H R
Prøve		Luftstævne		Aalborg Skyttekreds	
	1: 9.4	→		11: 9.3	↑
	2: 9.1	→		12: 9.4	↗
	3: 10.4x	↘		13: 9.9	←
	4: 10.5x	↗		14: 10.4x	↗
	5: 9.3	→		15: 10.2x	↗
	6: 10.2x	↗		16: 9.9	↑
	7: 10.0	↗		17: 10.0	→
	8: 9.4	→		18: 10.1	→
	9: 9.7	→		19: 10.7x	↘
	10: 10.2x	↗		20: 10.3x	↘
	Serie	98.2		Serie	100.2
	Total	0.0		Total	0.0
	21: 9.8	→		1: 10.2x	↗
	22: 10.2x	↘		2: 9.8	←
				3: 9.3	↑
				4: 10.6x	↓
				5: 9.1	→
				6: 10.1	→
				7: 10.0	↑
				8: 9.9	↗
				9: 10.1	→
				10: 10.5x	↓
	Serie	20.0		Serie	99.6
	Total	0.0		Total	99.6
	11: 10.4x	←		21: 10.4x	↘
	12: 10.5x	↗		22: 10.5x	↘
	13: 9.5	↗		23: 10.5x	↘
	14: 10.2x	↗		24: 9.3	←
	15: 10.7x	↗		25: 9.7	↗
	16: 10.5x	→		26: 10.5x	↑
	17: 10.1	↗		27: 9.9	←
	18: 10.4x	↗		28: 9.5	↗
	19: 9.8	←		29: 9.7	←
	20: 10.4x	→		30: 9.6	↗
	Serie	102.5		Serie	99.6
	Total	202.1		Total	301.7
	31: 9.5	↘		41: 10.4x	←
	32: 9.4	←		42: 10.5x	←
	33: 10.1	↗		43: 10.4x	↓
	34: 10.1	→		44: 10.3x	↘
	35: 10.4x	↓		45: 10.8x	↗
	36: 10.1	↓		46: 10.6x	→
	37: 9.9	↗		47: 9.6	↗
	38: 10.3x	→		48: 9.9	↓
	39: 10.4x	↘		49: 10.0	→
	40: 9.9	↘		50: 9.7	←
	Serie	100.1		Serie	102.2
	Total	401.8		Total	504.0
	51: 10.7x	↗			
	52: 10.3x	↗			
	53: 10.4x	→			
	54: 9.9	↘			
	55: 10.8x	↑			
	56: 10.5x	←			
	57: 10.8x	↑			
	58: 10.0	↗			
	59: 9.9	↗			
	60: 10.6x	←			
	Serie	103.9			
	Total	607.9			

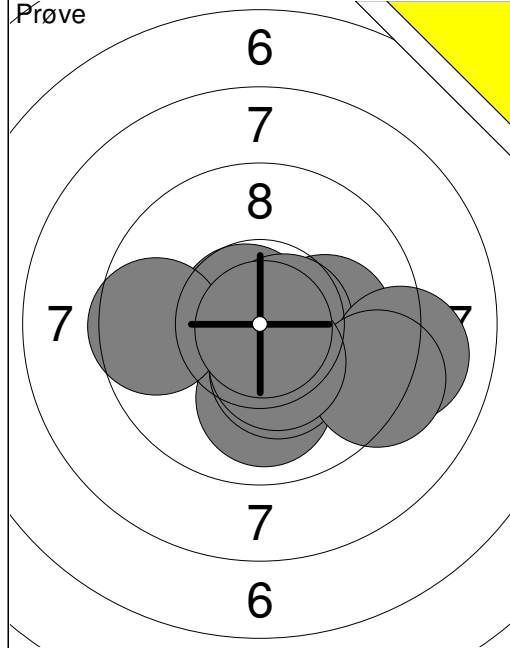

1:	10.1 →
2:	10.7 ✕
3:	10.0 ↓
4:	10.6 ✕ →
5:	9.6 ←
6:	10.3 ✕ ↓
7:	9.1 →
8:	9.3 →
9:	10.4 ✕ ↓
10:	10.9 ✕ ↓
Serie	101.0
Total	0.0

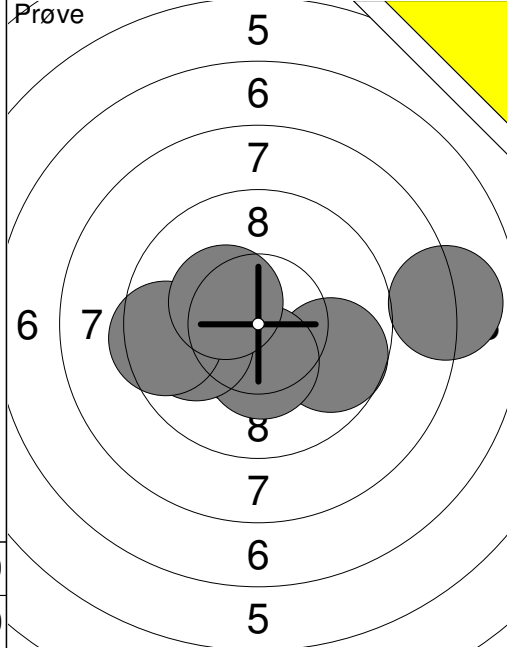

11:	10.4 ✕
12:	9.7 →
13:	10.4 ✕ ↓
14:	9.9 ←
15:	9.5 ←
16:	10.3 ✕
17:	8.0 →
Serie	68.2
Total	0.0

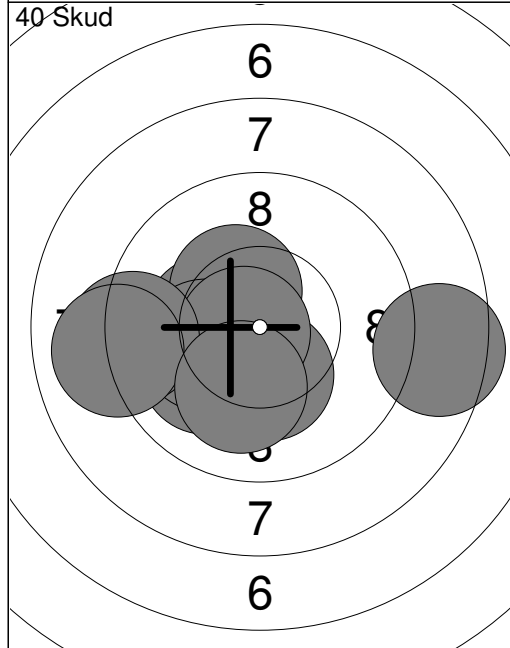

1:	8.5 →
2:	10.3 ✕
3:	10.3 ✕ ↓
4:	10.4 ✕
5:	10.0 ↙
6:	10.2 ✕
7:	10.7 ✕
8:	9.2 ←
9:	9.0 ←
10:	10.1 ↓
Serie	98.7
Total	98.7

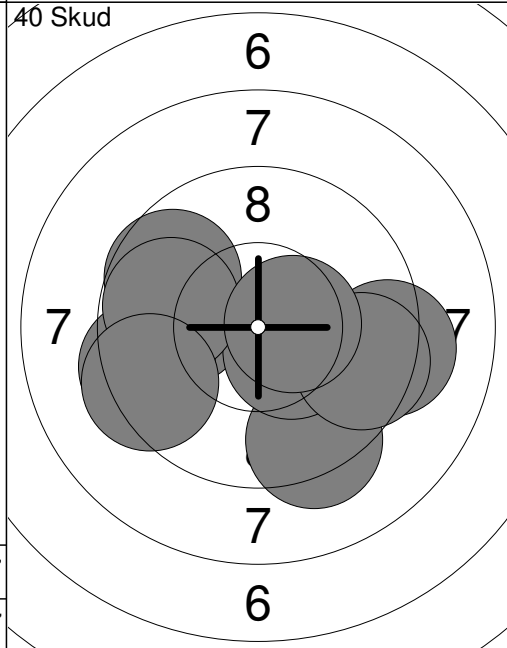

11:	9.3 ↓
12:	9.9 ←
13:	9.7 ↙
14:	10.4 ✕ ↓
15:	9.4 ←
16:	9.2 →
17:	9.8 ←
18:	9.5 →
19:	10.5 ✕ →
20:	9.4 ↙
Serie	97.1
Total	195.8

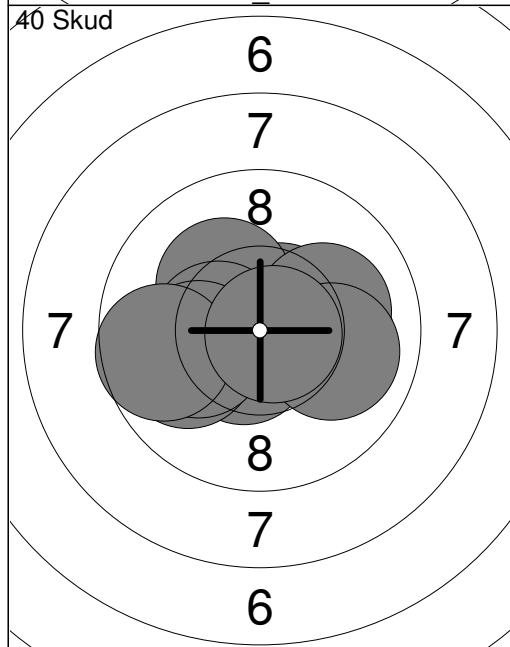

21:	10.6 ✕ ↗
22:	10.2 ✕
23:	10.6 ✕ ↓
24:	10.4 ✕ ←
25:	9.9 ←
26:	10.1 ↙
27:	10.1 →
28:	9.7 ←
29:	10.0 →
30:	10.8 ✕ →
Serie	102.4
Total	298.2

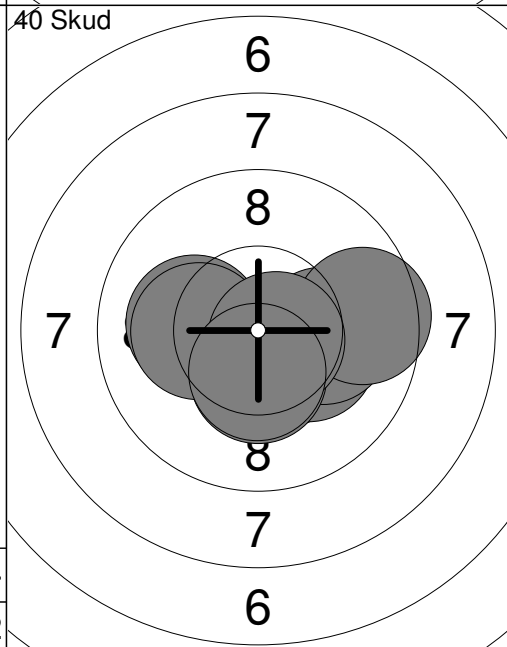

31:	10.6 ✕ ↓
32:	10.5 ✕ ↓
33:	10.2 ✕ →
34:	10.1 →
35:	10.1 ←
36:	9.6 →
37:	10.4 ✕ ↓
38:	10.2 ✕ ←
39:	10.7 ✕ →
40:	10.4 ✕ ↓
Serie	102.8
Total	401.0

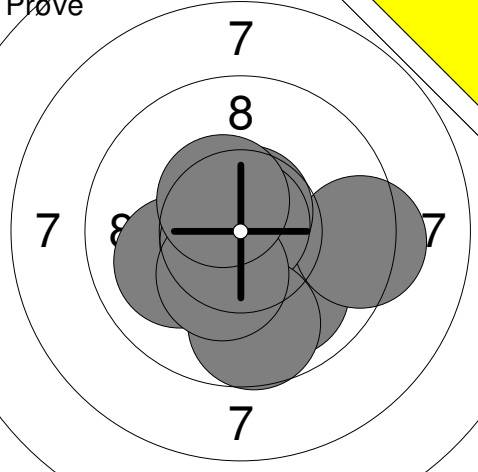
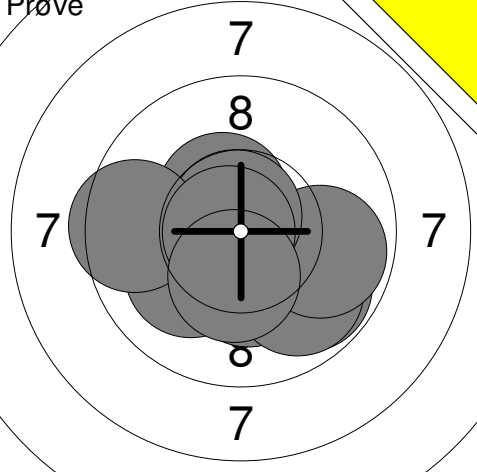
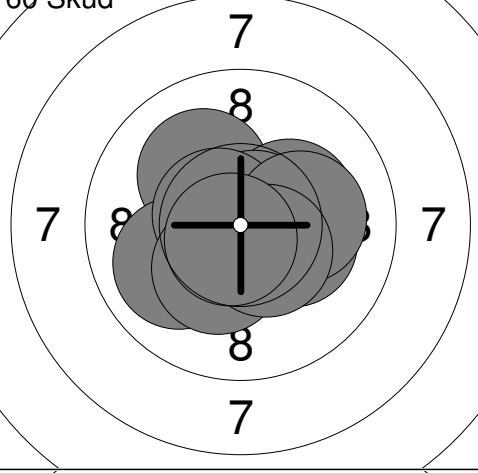
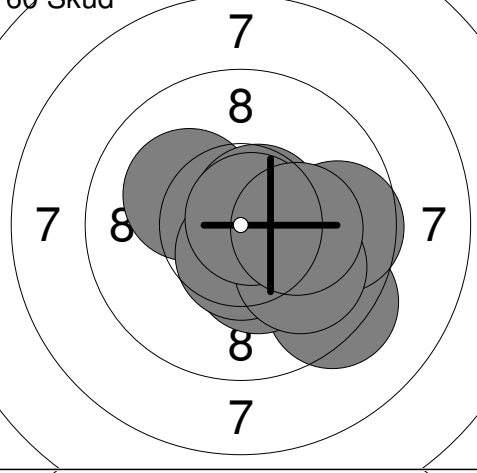
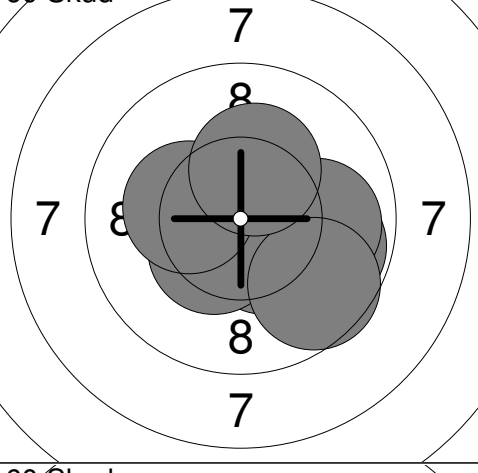
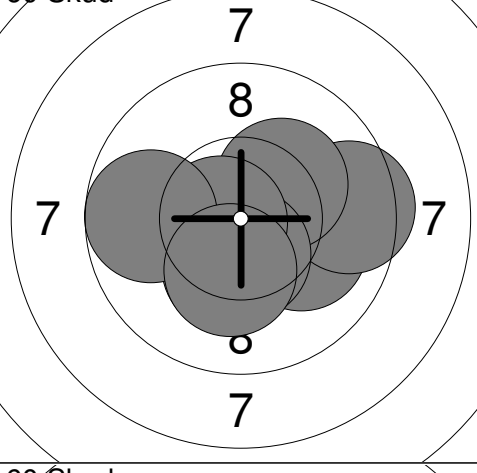
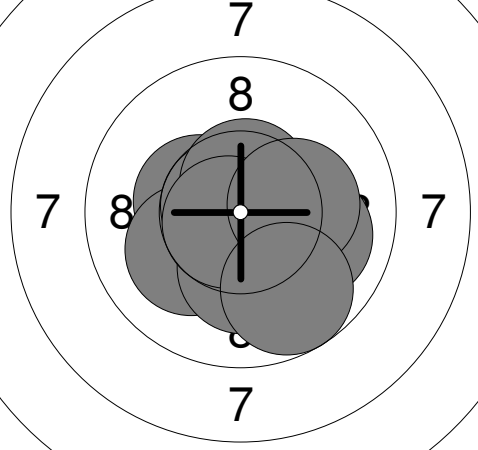
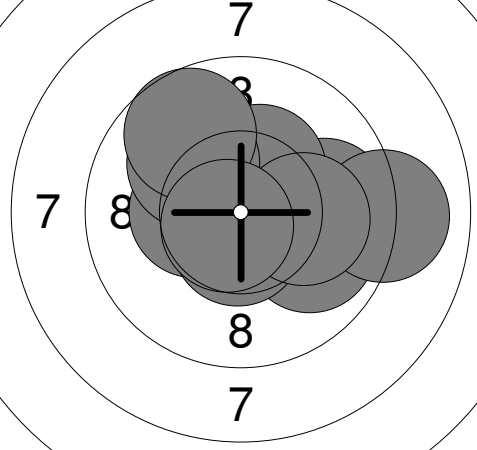
Prøve 	1: 10.0 ↙ 2: 10.9x ↓ 3: 10.7x ↙ 4: 10.0 ↓ 5: 9.3 → 6: 10.7x ↗ 7: 10.8x ↗ 8: 9.7 ↓ 9: 10.3x ↓ 10: 10.5x ↗ <hr/> Serie 102.9 Total 0.0	Prøve 	11: 9.8 ↘ 12: 10.3x ↓ 13: 10.4x ↗ 14: 10.1 ↙ 15: 9.9 ↓ 16: 9.8 → 17: 10.7x ↗ 18: 9.5 ← 19: 10.8x ← 20: 10.3x ↓ <hr/> Serie 101.6 Total 0.0
60 Skud 	1: 10.1 ↗ 2: 10.2x → 3: 10.7x ↗ 4: 10.0 ↙ 5: 10.6x ↗ 6: 10.3x ↓ 7: 10.2x → 8: 10.1 → 9: 10.5x ↓ 10: 10.7x ↓ <hr/> Serie 103.4 Total 103.4	60 Skud 	11: 9.3 ↘ 12: 10.1 ↗ 13: 10.6x ↗ 14: 9.6 → 15: 10.5x → 16: 10.3x ↓ 17: 10.6x ↓ 18: 10.0 ↘ 19: 10.8x ↗ 20: 10.2x → <hr/> Serie 102.0 Total 205.4
60 Skud 	21: 10.3x ↘ 22: 10.4x ↓ 23: 9.8 ↘ 24: 10.7x → 25: 9.9 → 26: 10.6x ← 27: 10.4x ↙ 28: 10.2x ← 29: 9.6 ↘ 30: 10.3x ↗ <hr/> Serie 102.2 Total 307.6	60 Skud 	31: 10.1 → 32: 10.1 → 33: 9.5 → 34: 10.7x ↓ 35: 10.2x ↗ 36: 10.3x ↓ 37: 10.5x ↓ 38: 10.7x ← 39: 9.7 ← 40: 10.2x ↓ <hr/> Serie 102.0 Total 409.6
60 Skud 	41: 10.0 → 42: 10.4x ← 43: 10.1 ↙ 44: 10.2x ↓ 45: 10.7x ↗ 46: 10.7x ↗ 47: 10.6x ↗ 48: 10.7x ↙ 49: 10.2x → 50: 9.7 ↓ <hr/> Serie 103.3 Total 512.9	60 Skud 	51: 9.8 → 52: 10.3x ↗ 53: 10.3x ← 54: 10.0 ↗ 55: 9.9 ↘ 56: 10.6x ↓ 57: 9.0 → 58: 10.1 → 59: 9.7 ↗ 60: 10.7x ↙ <hr/> Serie 100.4 Total 613.3

Hold	Skive	Henrik Strand		H	R
53	11	Viborg Skytteforening			
AAS		Luftstævne		Aalborg Skyttekreds	
Prøve		1: 9.9 ↗ 2: 9.3 ↗ 3: 8.1 ↗ 4: 9.1 ↗ 5: 9.2 ↗ 6: 9.7 ↖ 7: 9.6 ↖ 8: 10.0 ↑ 9: 10.8x → 10: 9.8 ↗	Prøve	11: 10.8x ↗ 12: 10.3x ↖ 13: 10.7x ↑ 14: 9.9 ↓ 15: 10.8x → 16: 9.0 ↖ 17: 9.6 ↖ 18: 10.3x → 19: 9.8 ↗ 20: 10.4x ↖	
		Serie 95.5 Total 0.0		Serie 101.6 Total 0.0	
Prøve		21: 10.0 ↖ 22: 10.2x ↗ 23: 10.4x ↑	60 Skud	1: 10.8x ↘ 2: 10.1 → 3: 10.2x ↘ 4: 10.5x ↖ 5: 10.2x ↖ 6: 10.9x ↗ 7: 9.8 → 8: 10.2x ↗ 9: 9.9 ↗ 10: 10.3x ↖	
		Serie 30.6 Total 0.0		Serie 102.9 Total 102.9	
60 Skud		11: 9.7 → 12: 9.1 ↖ 13: 10.5x ↗ 14: 10.7x ↘ 15: 10.1 → 16: 10.4x ↗ 17: 10.2x ↘ 18: 10.1 ↗ 19: 10.3x → 20: 10.0 →	60 Skud	21: 9.5 ↖ 22: 8.8 → 23: 10.3x ↗ 24: 10.3x ↘ 25: 10.6x ↗ 26: 10.4x ↖ 27: 10.3x → 28: 10.5x ↓ 29: 10.5x ↓ 30: 10.0 ↖	
		Serie 101.1 Total 204.0		Serie 101.2 Total 305.2	
60 Skud		31: 10.2x → 32: 10.4x ↗ 33: 9.8 ↗ 34: 9.9 ↖ 35: 10.2x ↑ 36: 9.8 ↖ 37: 10.2x ↗ 38: 10.4x → 39: 10.4x → 40: 10.5x ↖	60 Skud	41: 10.6x ↑ 42: 10.2x ↘ 43: 10.4x ↑ 44: 9.5 → 45: 9.0 ↗ 46: 10.2x ↘ 47: 10.7x ↖ 48: 10.3x ↘ 49: 10.3x ↘ 50: 10.4x ↑	
		Serie 101.8 Total 407.0		Serie 101.6 Total 508.6	
60 Skud		51: 10.2x ↖ 52: 9.7 ↖ 53: 10.6x ↗ 54: 10.0 ↗ 55: 10.4x ↖ 56: 9.7 ↗ 57: 10.2x ↑ 58: 9.6 ↗ 59: 8.7 → 60: 9.8 →			
		Serie 98.9 Total 607.5			

Hold	Skive	Kristian Johansen	
53	12		
AAS		Viborg Skytteforening	U15-2 R
Luftstævne		Aalborg Skyttekreds	
Prøve		1: 10.2x↘ 2: 9.6 ↓ 3: 10.2x↘ 4: 9.7 ↓ 5: 9.9 → 6: 10.3x→ 7: 10.8x↘ 8: 10.1 ↖ 9: 10.6x↘ 10: 10.3x↗ Serie 101.7 Total 0.0	Prøve 11: 9.6 ← 12: 10.5x↘ 13: 9.9 ↓ 14: 9.9 ↓ 15: 10.1 ↓ 16: 10.0 ↘ 17: 10.7x↘ 18: 10.7x↘ 19: 10.4x↘ Serie 91.8 Total 0.0
40 Skud		1: 10.0 ↑ 2: 9.3 ↗ 3: 10.0 ↙ 4: 10.6x↘ 5: 10.4x↘ 6: 10.4x↘ 7: 10.6x↘ 8: 10.5x↘ 9: 10.1 → 10: 9.8 ↑ Serie 101.7 Total 101.7	40 Skud 11: 10.1 → 12: 10.7x↘ 13: 10.7x↗ 14: 10.0 ↖ 15: 10.6x↘ 16: 10.7x→ 17: 10.8x↘ 18: 10.7x↘ 19: 10.6x↘ 20: 10.5x↘ Serie 105.4 Total 207.1
40 Skud		21: 10.0 ↘ 22: 10.1 ← 23: 10.3x↗ 24: 10.4x↗ 25: 10.6x↗ 26: 9.9 → 27: 10.9x↗ 28: 10.2x↘ 29: 10.4x↘ 30: 10.3x↗ Serie 103.1 Total 310.2	40 Skud 31: 10.3x→ 32: 10.2x↖ 33: 10.5x↘ 34: 10.3x↘ 35: 10.1 ↗ 36: 10.5x↘ 37: 10.5x↖ 38: 10.1 → 39: 9.8 ← 40: 10.2x↘ Serie 102.5 Total 412.7